



目录 (catalogue)

型 号 REFERENCE	描述 DESCRIPTION	页数 PAGE
01100	FERRULE FOR CHINA1-WIRE HOSE	2
01200	FERRULE FOR CHINA2-WIRE HOSE	2
01300	FERRULE FOR CHINA3-WIRE HOSE	3
01400	FERRULE FOR R12/20-24& 'FEIYU' 4-SPIRAL HOSE	3
00100	FERRULE FOR SAE 100R1AT/DIN20022 1ST HOSE	4
00110	FERRULE FOR SAE 100RIAT/DIN20022 1SN HOSE	4
00110-A	FERRULE FOR SAE 100RIAT/DIN20022 1SN HOSE	5
00200	FERRULE FOR SAE 100R2AT/DIN20022 2ST HOSE	5
00210	FERRULE FOR SAE 100R2AT/DIN20022 2SN HOSE	6
03310	FERRULE FOR SAE 100R2AT/DIN20022 2SN HOSE	6
00400	FERRULE FOR 4SP、4SH/10-16、R12/06-16 HOSE	7
00401	FERRULE FOR R12/20-24 HOSE	7
00018	FERRULE FOR SAE 100R7 HOSE	8
00TFO	FERRULE FOR TEFLON HOSE	8
00500	FERRULE FOR SAE 100 R5 HOSE	9
00621	FERRULE FOR GB/T 10544 R13/SAE 100 R13/EN856 R13 HOSE	9
10311	O-RING METRIC MALE FLAT SEAT	14
20211 20211-T	METRIC FEMALE FLAT SEAT	15
20241 20241-T	45° METRIC FEMALE FLAT SEAT	16
20291 20291-T	90° METRIC FEMALE FLAT SEAT	17
10411	METRIC MALE 24° CONE SEAT L.T.	18
20411 20411-T	METRIC FEMALE 24° CONE O-RING L.T.	19
20411C	METRIC FEMALE MULTISEAL 24° CONE L.T.	20
20411C-T		
20441 20441-T	45° METRIC FEMALE 24° CONE L.T.	21
20491 20491-T	90° METRIC FEMALE 24° CONE O-RING L.T.	22
20491C	90° METRIC FEMALE 24° CONE MULTISEAL L.T.	23
20491C-T		23
10511	METRIC MALE 24° CONE SEAT H.T.	24
20511 20511-T	METRIC FEMALE 24° CONE O-RING H.T.	25
20511C	METRIC FEMALE 24° MULTISEAL H.T.	26
20511C-T		
20541 20541-T	45° METRIC FEMALE 24° CONE O-RING H.T.	27
20541C	45° METRIC FEMALE 24° MULTISEAL H.T.	28
20541C-T		
20591 20591-T	90° METRIC FEMALE 24° CONE O-RING H.T.	29
20591C	90° METRIC FEMALE 24° MULTISEAL H.T.	30
20591C-T		

目录CATALOGUE





10611	METRIC MALE DOUBLE USE FOR 60°	31
20611 20611-T	METRIC FEMALE 60° CONE	32
20691 20691-T	90° METRIC FEMALE 60° CONE	33
10711	METRIC MALE 74° CONE	34
20711 20711-T	METRIC FEMALE 74° CONE SEAT	35
20741	45° METRIC FEMALE 74° CONE SEAT	36
20791	90° METRIC FEMALE 74° CONE SEAT	37
10811L	METRIC MALE 90° CONE	38
20111 20111-T	METRIC FEMALE MULTISEAL	39
20141 20141-T	45° METRIC FEMALE MULTISEAL	40
20191 20191-T	90° METRIC FEMALE MULTISEAL	41
50011	METRIC STANDPIPE STRAIGHT	42
50091	90° METRIC STANDPIPE STRAIGHT	43
51011	BSP STANDARD PIPE	44
51091	90° BSP STANDARD PIPE	45
NS NL	RETAINING NUT L.T.	46
12211	BSP MALE O-RING SEAL	47
12611	BSP MALE 60° CONE SEAT	48
12611A	BSP MALE DOUBLE USE FOR 60° CONE SEAT OR BONDED SEAL	49
22611 22611-T	BSP FEMALE 60° CONE	50
22611-W		
22611D	BSP FEMALE 60° CONE DOUBLE HEXAGON	51
22611D-SM	BSP FEMALE 60° CONE DOUBLE HEXAGON	51
22641 22641-T	45° BSP FEMALE 60° CONE	52
22641-W		
22691 22691-T	90° BSP FEMALE 60° CONE	53
22691-W		
22691K	BSP FEMALE CONE DOUBLE HEXAGON	54
22111 22111-T	BSP FEMALE MULTISEAL	55
22111-W		
22141 22141-T	45° BSP FEMALE MULTISEAL	56
22141-W		
22191 22191-T	90° BSP FEMALE MULTISEAL	57
22191-W		
13011-SP	BSP MALE	58
14211	ORFS MALE O-RING SEAL	59
24211 24211-T	ORFS FEMALE FLAT SEAT	60
24211-W		
24291 24291-T	90° ORFS FEMALE FLAT SEAT ISO 12151-1—SAE J516	61
24291-W		
15611	NPT MALE	62
16011	SAE O-RING SEAL	63
16711L	JIC 74° MALE CONE SEAL LONGER	64
16711	JIC 74° MALE CONE SEAL	65

目录CATALOGUE

26711	JIC FEMALE 74° CONE SEAT	66
26741 26741W	45° JIC FEMALE 74° CONE SEAT	67
26791 26791W	90° JIC FEMALE 74° CONE SEAT	68
26791K	90° JIC COMPACT FEMALE 74° CONE SEAT	69
17811	SAE MALE 90° CONE	69
27811	SAE FEMALE 90° CONE SEAT	70
21611	NPSM FEMALE 60° CONE	71
87312	SAE FLANGE 3000 PSI	72
87342	45° SAE FLANGE 3000 PSI	73
87392	90° SAE FLANGE 3000 PSI	74
87392-H	90° SAE FLANGE SPECIAL HEIGHT	75
HALF	FL 3000 PSI HALF FLANGE	76
FLANGE	FS 6000 PSI HALF FLANGE	76
87612	SAE FLANGE 6000 PSI	77
87642	45° SAE FLANGE 6000 PSI	78
87692	90° SAE FLANGE 6000 PSI	79
18611	JIS METRIC MALE 60° CONE SEAT	80
28611 28611W	JIS METRIC FEMALE 60° CONE SEAT	81
28691 286912	90°JIS METRIC FEMALE 60° CONE SEAT	82
19611	JIS GAS FEMALE 60° CONE SEAT	83
29611 29611W	JIS GAS FEMALE 60° CONE SEAT	83
29691 29691W	90° JIS GAS FEMALE 60° CONE SEAT	84
88111	JIS FLANGE	85
88141	45° JIS FLANGE	85
88191	90° JIS FLANGE	86
20011-ST	METRIC FEMALE WATERWASH INSERTS 20011-ST	86
70011	METRIC BANJO	87
700M	METRIC BOLT	88
72011	BSP BANJO	89
720B	BSP BOLT	90
90011	DOUBLE CONNECTOR	90
90012	DOUBLE CONNECTOR	91

套筒 FERRULE

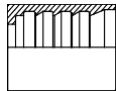
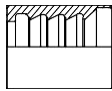
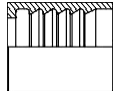
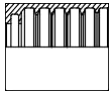
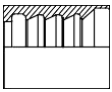
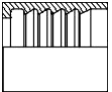
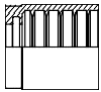
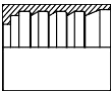
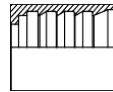
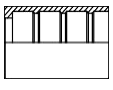
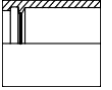
型号索引 (INDEX)

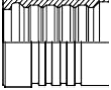
 01100	 01200	 01300	 01400	 00100	 00110
 00110-A	 00200	 00210	 03310	 00400	 00401
 00018	 00TF0	 00500	 00621		

套筒 FERRULE

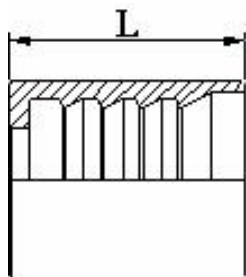

01100

国产一层编织胶管套筒
FERRULE FOR CHINA1-WIRE HOSE

代号 PART NO.	胶管HOSE BORE		尺寸DIMENSIONS		
	公称内径DN	标号DASH		L	
01100-03	5	03		28	
01100-04	6	04		30	
01100-05	8	05		32	
01100-06	10	06		32	
01100-08	12	08		34	
01100-10	16	10		39	
01100-12	20	12		43	
01100-14	22	14		43	
01100-16	25	16		50	
01100-20	32	20		59	
01100-24	40	24		74	
01100-32	50	32		78	

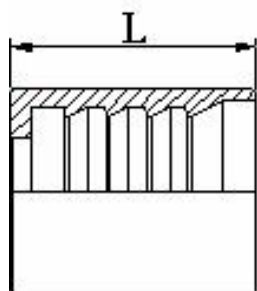

01200

国产二层编织胶管套筒
FERRULE FOR CHINA2-WIRE HOSE

代号 PART NO.	胶管HOSE BORE		尺寸DIMENSIONS		
	公称内径DN	标号DASH		L	
01200-03	5	03		28	
01200-04	6	04		30	
01200-05	8	05		32	
01200-06	10	06		32	
01200-08	12	08		34	
01200-10	16	10		39	
01200-12	20	12		43	
01200-14	22	14		43	
01200-16	25	16		50	
01200-20	32	20		59	
01200-24	40	24		74	
01200-32	50	32		78	

套筒 FERRULE

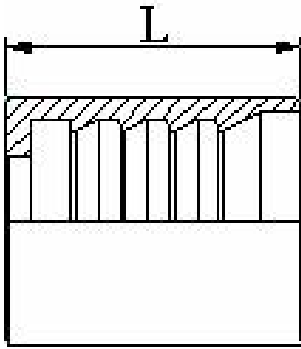

01300

国产三层编织胶管套筒
FERRULE FOR CHINA3-WIRE HOSE

代号 PART NO.	胶管HOSE BORE		尺寸DIMENSIONS		
	公称内径DN	标号DASH		L	
01300-04	6	04		30	
01300-05	8	05		32	
01300-06	10	06		32	
01300-08	12	08		34	
01300-10	16	10		39	
01300-12	20	12		43	
01300-14	22	14		43	
01300-16	25	196		50	
01300-20	32	20		59	
01300-24	40	24		74	
01300-32	50	32		78	

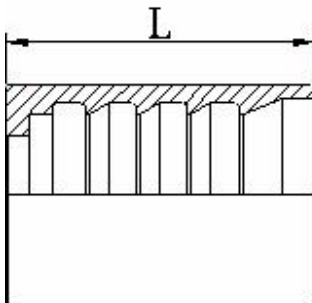

01400

R12/20-24 及国产飞宇牌四层钢丝缠绕胶管套筒
FERRULE FOR R12/20-24& 'FEIYU' 4-SPIRAL HOSE

代号 PART NO.	胶管HOSE BORE		尺寸DIMENSIONS		
	公称内径DN	标号DASH		L	
01400-04	6	04		37.5	
01400-06	10	06		39	
01400-08	12	08		41	
01400-10	16	10		43	
01400-12	20	12		51	
01400-14	22	14		54	
01400-16	25	196		61.5	
01400-20	32	20		67.5	
01400-24	40	24		75	
01400-32	50	32		79	

套筒 FERRULE

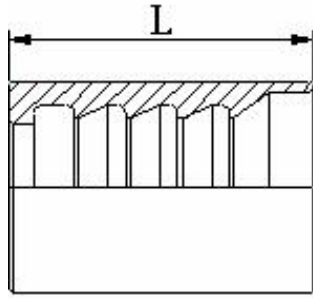

00100

SAE 100RIA/DIN20022 1ST 胶管套筒
FERRULE FOR SAE 100R1AT/DIN20022 1ST HOSE

代号 PART NO.	胶管HOSE BORE		尺寸DIMENSIONS		
	公称内径DN	标号DASH		L	
00100-02	4	02		27	
00100-04	6	04		30	
00100-05	8	05		31	
00100-06	10	06		32	
00100-08	12	08		34	
00100-10	16	10		37	
00100-12	20	12		43	
00100-16	25	16		50	
00100-20	32	20		59	
00100-24	40	24		74	
00100-32	50	32		78	

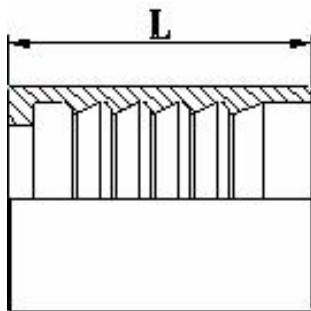

00110

SAE 100R1AT/DIN20022 1SN 胶管套筒
FERRULE FOR SAE 100R1AT/DIN20022 1SN HOSE

代号 PART NO.	胶管HOSE BORE		尺寸DIMENSIONS		
	公称内径DN	标号DASH		L	
00110-03	5	03		24.5	
00110-04	6	04		30	
00110-05	8	05		31	
00110-06	10	06		32	
00110-08	12	08		34	
00110-10	16	10		37	
00110-12	20	12		43	
00110-16	25	16		50	
00110-20	32	20		59	
00110-24	40	24		74	
00110-32	50	32		78	

套筒 FERRULE

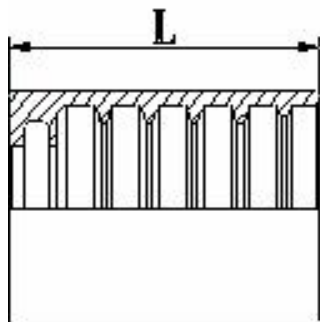

00110-A

SAE 100R1AT/DIN20022 1SN 软管套筒
FERRULE FOR SAE 100R1AT/DIN20022 1SN HOSE

代号 PART NO.	胶管HOSE BORE		尺寸DIMENSIONS		
	公称内径DN	标号DASH		L	
00110-03A	5	03		23	
00110-04A	6	04		30.5	
00110-05A	8	05		30	
00110-06A	10	06		32	
00110-08A	12	08		34	
00110-10A	16	10		37	
00110-12A	20	12		42	
00110-16A	25	16		51	

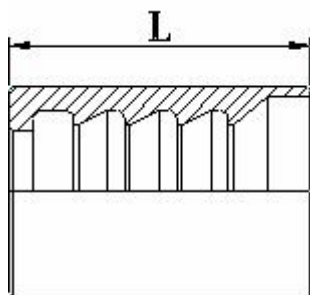

00200

SAE 100R2A/DIN20022 2ST 胶管套筒
FERRULE FOR SAE 100R2AT/DIN20022 2ST HOSE

代号 PART NO.	胶管HOSE BORE		尺寸DIMENSIONS		
	公称内径DN	标号DASH		L	
00200-02	4	02		27	
00200-04	6	04		30	
00200-05	8	05		31	
00200-06	10	06		32	
00200-08	12	08		34	
00200-10	16	10		37	
00200-12	20	12		43	
00200-16	25	16		50	
00200-20	32	20		59	
00200-24	40	24		74	
00200-32	50	32		78	

套筒 FERRULE

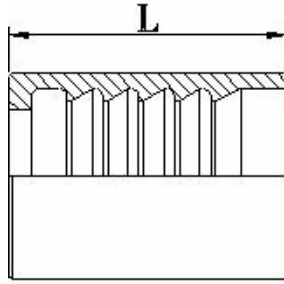

00210

SAE 100R2AT/EN 853 2SN 软管套筒
FERRULE FOR SAE 100R2AT/DIN20022 2SN HOSE

代号 PART NO.	胶管HOSE BORE		尺寸DIMENSIONS		
	公称内径DN	标号DASH		L	
00210-03	5	03		24.5	
00210-04	6	04		30	
00210-05	8	05		31	
00210-06	10	06		32	
00210-08	12	08		34	
00210-10	16	10		37	
00210-12	20	12		43	
00210-16	25	16		50	
00210-20	32	20		59	
00210-24	40	24		74	
00210-32	50	32		78	

注:不推荐用于工程机械

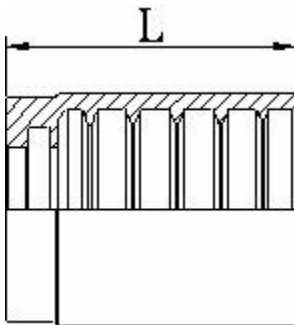

03310

SAE 100R2AT/EN 853 2SN 软管套筒
FERRULE FOR SAE 100R2AT/DIN20022 2ST HOSE

代号 PART NO.	胶管HOSE BORE		尺寸DIMENSIONS		
	公称内径DN	标号DASH		L	
03310-03	5	03		23	
03310-04	6	04		30.5	
03310-05	8	05		30	
03310-06	10	06		32	
03310-08	12	08		34	
03310-10	16	10		37	
03310-12	19	12		42	
03310-16	25	16		51	
03310-20	32	20		59	
03310-24	40	24		67	
03310-32	50	32		72	

套筒 FERRULE

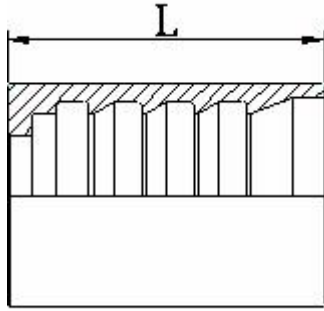

00400

4SP、4SH/12-16、R12/06-16 软管套筒
 FERRULE FOR 4SP、4SH/10-16、R12/06-16 HOSE

代号 PART NO.	胶管HOSE BORE		尺寸DIMENSIONS		
	公称内径DN	标号DASH		L	
00400-04	6	04		37.5	
00400-06	10	06		39	
00400-08	12	08		41	
00400-10	16	10		43	
00400-12	20	12		51	
00400-16	25	16		61.5	
00400-20	32	20		67.5	
00400-24	40	24		75	
00400-32	50	32		79	

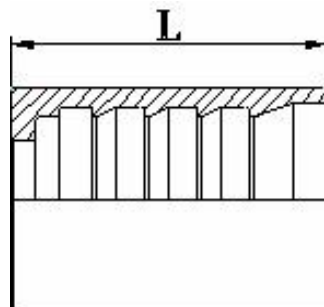

00401

4SH、R12/326 软管套筒
 FERRULE FOR 4SP、4SH/10-16、R12/06-16 HOSE

代号 PART NO.	胶管HOSE BORE		尺寸DIMENSIONS		
	公称内径DN	标号DASH		L	
00401-20	32	20		67.5	
00401-24	40	24		75	
00401-32	50	32		79	

套筒 FERRULE

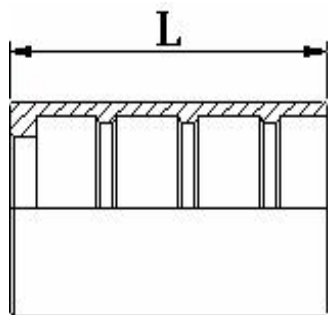

00018

SAE 100 R7 软管套筒

FERRULE FOR SAE 100R7 HOSE

代号 PART NO.	胶管HOSE BORE		尺寸DIMENSIONS		
	公称内径DN	标号DASH		L	
00018-03	5	03		27	
00018-04	6	04		29	
00018-05	8	05		31	
00018-06	10	06		31	
00018-08	12	08		34	
00018-10	16	10		36	
00018-12	20	12		43	
00018-16	25	16		50	

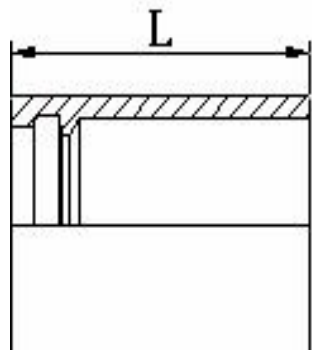

00TF0

铁氟龙套筒

FERRULE FOR TEFLON HOSE

代号 PART NO.	胶管HOSE BORE		尺寸DIMENSIONS		
	公称内径DN	标号DASH		L	
00TF0-03	4	03		26.5	
00TF0-04	6	04		30.7	
00TF0-05	8	05		30.6	
00TF0-06	10	06		32.1	
00TF0-08	12	08		34.3	
00TF0-10	16	10		37	
00TF0-12	20	12		42.8	
00TF0-14	22	14		42.7	
00TF0-16	25	16		50.8	

套筒 FERRULE

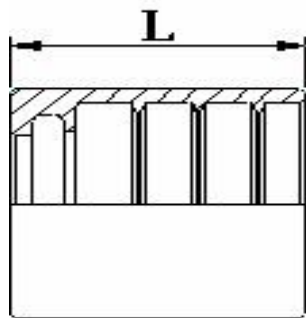

00500

SAE 100 R5 胶管套筒

FERRULE FOR SAE 100 R5 HOSE

代号 PART NO.	胶管HOSE BORE			尺寸DIMENSIONS		
	公称内径DN	标号DASH	SAE 标 号		L	
00500-03	4	03	04		22.6	
00500-04	6	04	05		25.7	
00500-05	8	05	06		22.4	
00500-07	11	07	08		26.2	
00500-08	12	08	10		27.7	
00500-10	16	10	12		29.7	
00500-14	22	14	16		33.5	
00500-18	28	18	20		42.7	
00500-22	35	22	24		47	
00500-29	46	29	32		50.8	
00500-38	60	38	40		63.0	

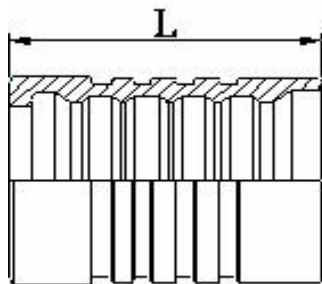

00621



GB/T 10544 R13/SAE 100 R13/EN856 R13

FERRULE FOR FERRULE FOR SAE 100 R5 HOSE



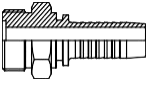
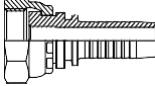
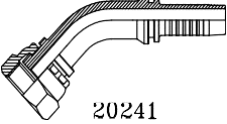
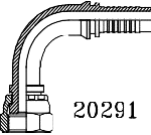
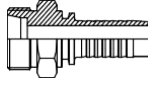
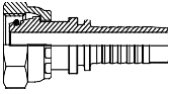
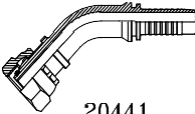
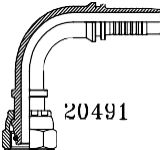
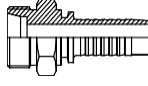
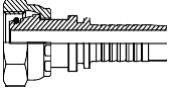
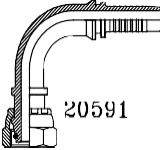

软管剥内外胶套筒

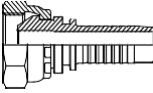
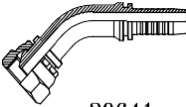
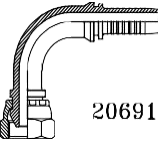
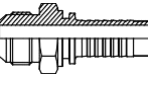
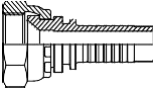
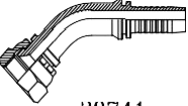
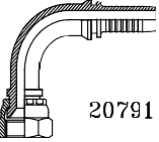
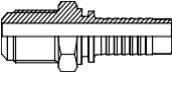
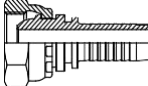
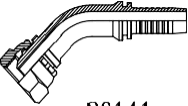
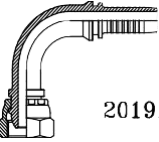
代号 PART NO.	胶管HOSE BORE			尺寸DIMENSIONS		
	公称内径DN	标号DASH			L	
00621-12	20	12			53	
00621-16	25	15			66	
00621-20	32	20			88.5	
00621-24	40	24			102	
00621-32	50	32			108	



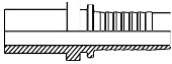
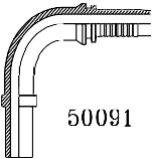

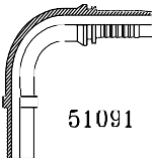
型号索引 (INDEX)

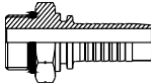
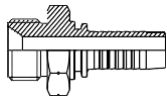
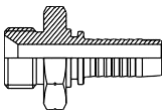
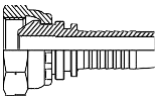
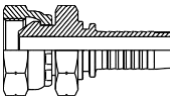
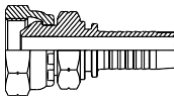
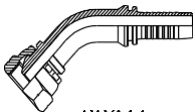
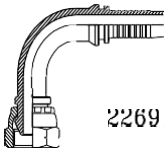
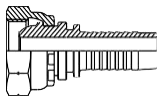
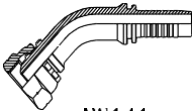
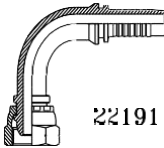
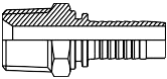
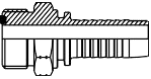
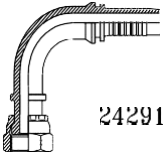
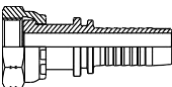
 10311	 20211	 20241	 20291
 10411	 20411	 20441	 20491
 10511	 20511		 20591
 10611	 20611	 20641	 20691
 10711	 20711	 20741	 20791
 10811L			
 20111	 20141	 20191	

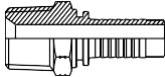

软管接头 HOSE FITTING

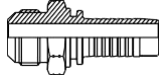
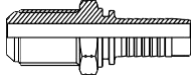
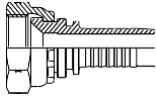
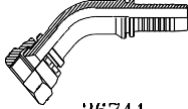
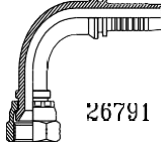
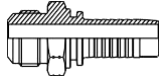
 <p>50011</p>	 <p>50091</p>	 <p>51011</p>	 <p>51091</p>	
 <p>12211</p>				
 <p>12611</p>	 <p>12611A</p>	 <p>22611</p>	 <p>22611D</p>	 <p>22611D-SM</p>
 <p>22641</p>	 <p>22691</p>			
 <p>22111</p>	 <p>22141</p>	 <p>22191</p>		
 <p>13011-SP</p>				
 <p>14211</p>	 <p>24291</p>	 <p>24211</p>		

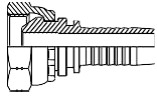
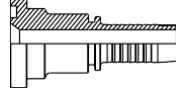
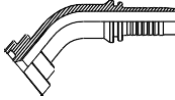
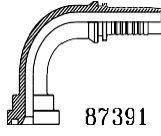
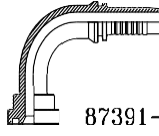
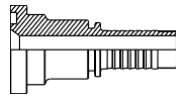
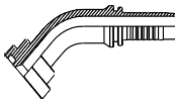
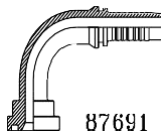
软管接头 HOSE FITTING

 <p>15611</p>				
 <p>16011</p>				
 <p>16711</p>	 <p>16711L</p>	 <p>26711</p>	 <p>26741</p>	 <p>26791</p>
 <p>17811</p>	 <p>27811</p>			
 <p>21611</p>				
 <p>87311</p>	 <p>87341</p>	 <p>87391</p>	 <p>87391-H</p>	
 <p>87611</p>	 <p>87641</p>	 <p>87691</p>		

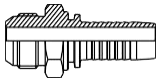
软管接头 HOSE FITTING

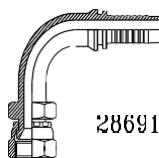
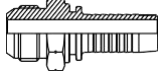
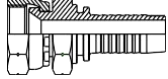
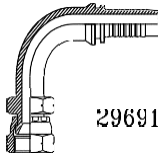
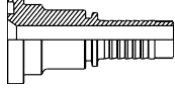
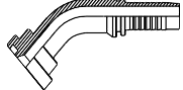
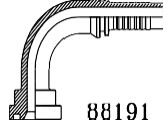
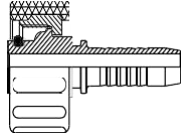
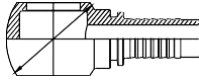
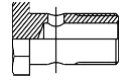
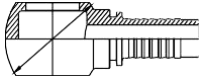
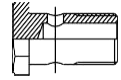
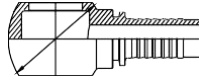
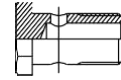
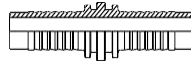
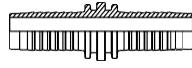
					
18611	28611	28691			
					
19611	29611	29691			
					
88111	88141	88191			
					
20011-ST					
					
70011	700M	71011	710M	72011	720B
					
90011	90012				

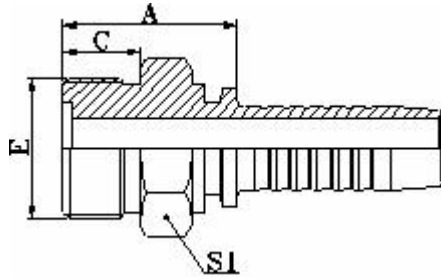

10311

公制外螺纹平面O形圈密封
O-RING METRIC MALE FLAT SEAT

代 号	螺 纹 E	软 管		尺 寸		
		公称内径	标 号	A	C	S1
10311-12-04	M12X1.25	6	04	22.5	10	14
10311-14-04	M14X1.5	6	04	23.5	11	14
10311-16-04	M16X1.5	6	04	23.5	11	17
10311-16-05	M16X1.5	8	05	23.5	11	17
10311-16-06	M16X1.5	10	06	23.5	11	17
10311-18-06	M18X1.5	10	06	23.5	11	19
10311-22-05	M22X1.5	8	05	27	12	24
10311-22-06	M22X1.5	10	06	26	12	24
10311-22-08	M22X1.5	12	08	26.5	12	24
10311-27-10	M27X1.5	16	10	31.5	13	30
10311-30-12	M30X1.5	20	12	33.5	14	32
10311-36-12	M36X2	20	12	35.5	16	38
10311-36-14	M36X2	22	14	35.5	16	38
10311-39-16	M39X2	25	16	39	16	41
10311-45-20	M45X2	32	20	44.5	50	46
10311-52-24	M52X2	40	24	47.5	22	55
10311-64-32	M64X2	50	32	52.5	27	65

注: 1.上述代号用于编织软管。 2. 如需用于缠绕软管代号改为 10312-xx-xx。

NOTE : 1. FOR USE WITH BRAIDED HOSES 2. IF USE WITH SPIRAL HOSES , HOSE FITTINGS SERIES NUMBER IS 10312-XX-XX.

软管接头 HOSE FITTING

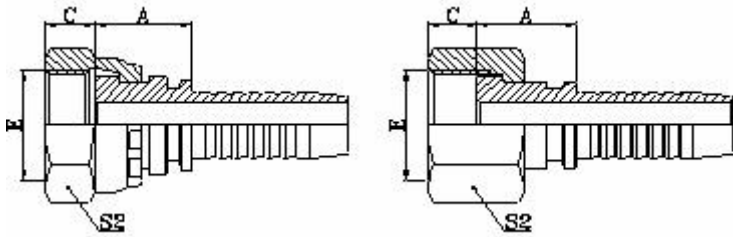

20211

20211-T

国标公制内螺纹平面
METRIC FEMALE FLAT SEAT

代 号	螺 纹 E	软 管		尺 寸		
		公称内径	标 号	A	C	S2
20211-10-02	M10X1	4	02	14	6	14
20211-12-03	M12X1.25	5	03	14	8	17
20211-14-04	M14X1.5	6	04	16	8.5	19
20211-14-05	M14X1.5	8	05	15.5	8.5	19
20211-16-04	M16X1.5	6	04	16.5	8	22
20211-16-05	M16X1.5	8	05	17	8	22
20211-16-06	M16X1.5	10	06	16.5	8	22
20211-18-05T	M18X1.5	8	05	17.5	8	24
20211-18-06	M20X1.5	10	06	18.5	8	24
20211-20-06T	M20X1.5	10	06	16	10	24
20211-20-08	M20X1.5	12	08	18.5	10	27
20211-22-06T	M22X1.5	10	06	16	10	27
20211-22-08	M22X1.5	12	08	19.5	10	27
20211-22-10	M22X1.5	16	10	19.5	10	27
20211-24-08T	M24X1.5	12	08	16.5	11	30
20211-24-10	M24X1.5	16	10	20.5	10.5	30
20211-27-08T	M27X1.5	12	08	18.5	10	32
20211-27-10T	M27X1.5	16	10	21	10	32
20211-30-12	M30X1.5	20	12	22	11	36
20211-33-14	M33X2	22	14	21.5	13	41
20211-36-12T	M36X2	20	12	24	13	41
20211-36-14T	M36X2	22	14	24	13	41
20211-39-16T	M39X2	25	16	25	13	46
20211-42-20W	M42X2	32	20	25	15	50
20211-45-20T	M45X2	32	20	27	15	55
20211-52-24T	M52X2	40	24	27	17	60
20211-60-28T	M60X2	45	28	26	20	70
20211-64-32T	M64X2	50	32	26	23	75

注: 1.上述代号用于编织软管。 2. 如需用于缠绕软管代号改为 20212-xx-xx。

NOTE : 1. FOR USE WITH BRAIDED HOSES 2. IF USE WITH SPIRAL HOSES , HOSE FITTINGS SERIES NUMBER IS 20212-XX-XX.

软管接头 HOSE FITTING

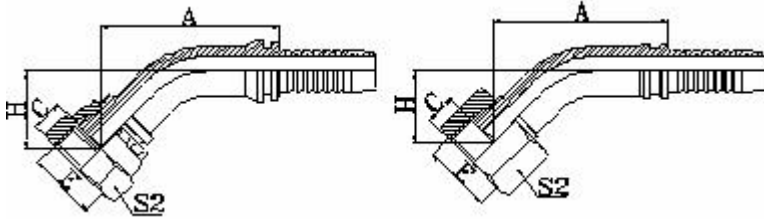

20241

20241-T

45°公制内螺纹平面
45° METRIC FEMALE FLAT SEAT

代 号	螺纹E	软 管		尺 寸			
		公称内径	标 号	A	C	H	S2
20241-14-04	M14X1.5	6	04	38	8.5	19	19
20241-14-05	M14X1.5	8	05	42.7	8.5	19.3	19
20241-16-05	M16X1.5	8	05	42.3	8.5	20.7	22
20241-18-06	M18X1.5	10	06	45.5	8	22	24
20241-22-08	M22X1.5	12	08	57.5	10	24.5	27
20241-27-10T	M27X1.5	16	10	58	10	24.5	32
20241-30-12T	M30X1.5	20	12	74	11	30	36
20241-36-12T	M36X2	20	12	75	13	27.5	41
20241-36-14T	M36X2	22	14	77.3	13	27	41
20241-36-16	M36X2	25	16	85.7	13	31.5	41
20241-39-16T	M39X2	25	16	82	13	30	46
20241-42-20W	M42X2	32	20	95.9	15	35.2	50
20241-45-20T	M45X2	32	20	94.5	15	35.5	55
20241-52-20T	M52X2	32	20	94.5	17	33.8	60
20241-52-24T	M52X2	40	24	105	17	38.5	60
20241-60-28T	M60X2	45	28	118.7	20	43.6	70
20241-62-32T	M64X2	50	32	127.8	23	45.6	75

注: 1.上述代号用于编织软管。 2. 如需用于缠绕软管代号改为 20242-xx-xx。

NOTE : 1. FOR USE WITH BRAIDED HOSES 2. IF USE WITH SPIRAL HOSES , HOSE FITTINGS SERIES NUMBER IS 20242-XX-XX.

软管接头 HOSE FITTING

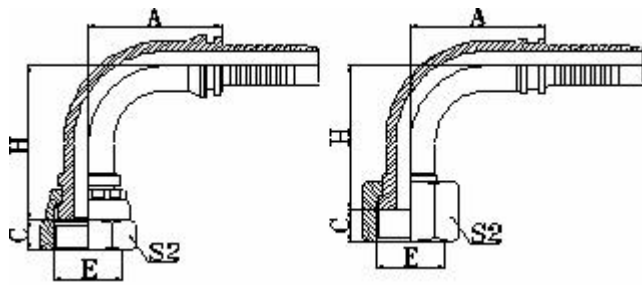

20291

20291-T

90°公制内螺纹平面
90° METRIC FEMALE FLAT SEAT

代 号	螺纹E	软 管		尺 寸			
		公称内径	标 号	A	C	H	S2
20291-12-02	M12X1.25	4	02	26.5	8	30.5	17
20291-12-04	M12X1.25	6	04	30	8	33.5	17
20291-14-04	M14X1.5	6	04	27.5	8.5	34	19
20291-14-05	M14X1.5	8	05	33	8.5	37	19
20291-16-04	M16X1.5	6	04	30	8	35	22
20291-16-05	M16X1.5	8	05	31	8	39.5	22
20291-16-06	M16X1.5	10	06	35.3	8	40.3	22
20291-18-05T	M18X1.5	8	05	33	8	39	24
20291-18-06	M18X1.5	10	06	33	8	42	24
20291-22-08	M22X1.5	12	08	42.5	10	49.5	27
20291-22-10	M22X1.5	16	10	57.5	10	53	27
20291-24-08T	M24X1.5	12	08	41	11	45.5	30
20291-27-04T	M27X1.5	6	04	30	10	35.5	32
20291-27-08T	M27X1.5	12	08	41	10	46	32
20291-27-10T	M27X1.5	16	10	48.5	10	51.5	32
20291-30-12	M30X1.5	20	12	50.5	11	63.5	36
20291-33-14	M33X2	22	14	71.2	13	65	41
20291-36-14T	M36X2	22	14	57.5	13	64	41
20291-36-16	M36X2	25	16	66	13	76.5	41
20291-39-16T	M39X2	25	16	66	13	72.5	46
20291-42-20W	M42X2	32	20	91.5	15	80.5	50
20291-45-20T	M45X2	32	20	75	15	85	55
20291-52-20T	M52X2	32	20	91.5	17	78.5	60
20291-52-24T	M52X2	40	24	89	17	97	60
20291-60-28T	M60X2	45	28	119.9	20	106.5	70
20291-64-32T	M64X2	50	32	130.95	23	113.3	75

注: 1.上述代号用于编织软管。 2. 如需用于缠绕软管代号改为 20292-xx-xx。

NOTE : 1. FOR USE WITH BRAIDED HOSES 2. IF USE WITH SPIRAL HOSES , HOSE FITTINGS SERIES NUMBER IS 20292-XX-XX.

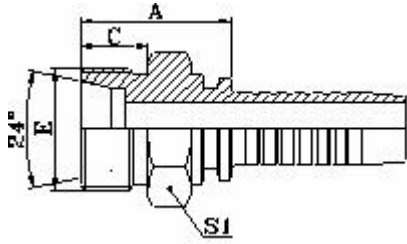

10411

公制外螺纹 24°内锥面轻系列
ISO 8434-1-DIN 3861
METRIC MALE 24°CONE SEAT L.T.

代 号	螺纹E	软 管		管子外径	尺 寸		
		公称内径	标 号		A	C	S2
10411-12-04	M12X1.5	6	04	6	22	10	12
10411-14-04	M14X1.5	6	04	8	22	10	14
10411-14-05	M14X1.5	8	05	8	22	10	14
10411-16-04	M16X1.5	6	04	10	23.5	11	17
10411-16-05	M16X1.5	8	05	10	23.5	11	17
10411-16-06	M16X1.5	10	06	10	23.5	11	17
10411-18-05	M18X1.5	8	05	12	24	11	19
10411-18-06	M18X1.5	10	06	12	24	11	19
10411-22-06	M22X1.5	10	06	15	26.5	12	24
10411-22-08	M22X1.5	12	08	15	27	12	24
10411-26-08	M26X1.5	12	08	18	28.5	12	27
10411-26-10	M26X1.5	16	10	18	29.5	12	27
10411-27-10	M27X1.5	16	10	18	32.5	14	30
10411-30-10	M30X2	16	10	22	33.5	14	32
10411-30-12	M30X2	20	12	22	33.5	14	32
10411-36-16	M36X2	25	16	28	36	14	38
10411-45-20	M45X2	32	20	35	40	16	46
10411-52-24	M52X2	40	24	42	43	16	55

注: 1.上述代号用于编织软管。 2. 如需用于缠绕软管代号改为 10412-xx-xx。

NOTE : 1. FOR USE WITH BRAIDED HOSES 2. IF USE WITH SPIRAL HOSES , HOSE FITTINGS SERIES NUMBER IS 10412-XX-XX.

软管接头 HOSE FITTING

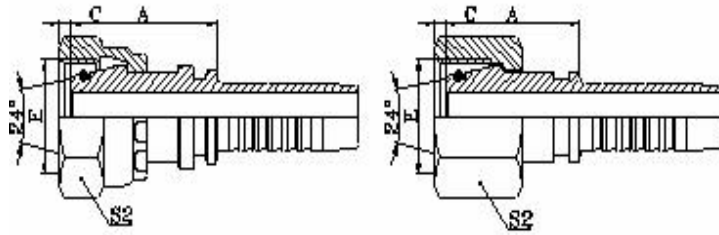

公制内螺纹 24°锥带 O 形圈轻系列
ISO 2151-2-DIN 3865
METRIC FEMALE 24° CONE O-RING L.T.

20411

20411-T

代 号	螺纹E	软 管		管子外径	O 形圈	尺 寸		
		公称内径	标 号			A	C	S2
20411-12-04	M12X1.5	6	04	6	O04.5X1.5	25	1	17
20411-14-04	M14X1.5	6	04	8	O06.5X1.5	26.5	2	19
20411-14-06	M14X1.5	10	06	8	O06.5X1.5	27.5	2	19
20411-16-04	M16X1.5	6	04	10	O08.0X1.5	27	2	22
20411-16-05	M16X1.5	8	05	10	O08.0X1.5	27	2	22
20411-16-06	M16X1.5	10	06	10	O08.0X1.5	28	2	22
20411-18-05T	M18X1.5	8	05	12	O10.0X1.5	25.5	1.5	22
20411-18-06	M18X1.5	10	06	12	O10.0X1.5	29	2.5	24
20411-18-08	M18X1.5	12	08	12	O10.0X1.5	29.5	2.5	24
20411-22-05T	M22X1.5	8	05	15	O12.0X2	26.5	3	27
20411-22-06T	M22X1.5	10	06	15	O12.0X2	28.5	3	27
20411-22-08	M22X1.5	12	08	15	O12.0X2	32.5	2.5	27
20411-26-10	M26X1.5	16	10	18	O15.0X2	34.5	2.5	32
20411-26-12	M26X1.5	20	12	18	O15.0X2	34.5	2.5	32
20411-30-10T	M30X2	16	10	22	O20.0X2	33	3.8	36
20411-30-12	M30X2	20	12	22	O20.0X2	36.5	4	36
20411-36-12T	M36X2	20	12	28	O26.0X2	36	4.5	46
20411-36-14T	M36X2	22	14	28	O26.0X2	36.5	4.5	46
20411-45-16T	M45X2	25	16	35	O32.0X2	42	4	55
20411-45-20T	M45X2	32	20	35	O32.0X2	43	4	55
20411-52-20T	M52X2	32	20	42	O38.0X2	44.5	4	60
20411-52-24T	M52X2	40	24	42	O38.0X2	44.5	4	60

注: 1.上述代号用于编织软管。 2. 如需用于缠绕软管代号改为 20412-xx-xx。

NOTE : 1. FOR USE WITH BRAIDED HOSES 2. IF USE WITH SPIRAL HOSES , HOSE FITTINGS SERIES NUMBER IS 20412-XX-XX.

20411C 20411C-T

公制内螺纹 24°球面 轻系列
METRIC FEMALE MULTISEAL 24° CONE L.T.

代 号	螺纹E	软 管		管子外径	尺 寸		
		公称内径	标 号		A	C	S2
20411C-12-04	M12X1.5	6	04	6	19.5	3.5	17
20411C-14-04	M14X1.5	6	04	8	20.5	3.5	19
20411C-16-04	M16X1.5	6	04	10	21	3.5	22
20411C-16-05	M16X1.5	8	05	10	21	3.5	22
20411C-16-06	M16X1.5	10	06	10	21	3.5	22
20411C-18-06	M18X1.5	10	06	12	22.5	3	24
20411C-22-06T	M22X1.5	10	06	15	23.5	4.5	27
20411C-22-08	M22X1.5	12	08	15	24	4.5	27
20411C-26-10	M26X1.5	16	10	18	27	4	32
20411C-30-10T	M30X2	16	10	22	26.5	7	36
20411C-30-12	M30X2	20	12	22	27	7	36
20411C-30-14	M30X2	22	14	22	27	7	36
20411C-36-16	M36X2	25	16	28	29	6.5	41
20411C-45-20T	M45X2	32	20	35	33	7	55
20411C-52-24T	M52X2	40	24	42	34	8	60

注: 1.上述代号用于编织软管。 2. 如需用于缠绕软管代号改为 20412C-xx-xx。
NOTE : 1. FOR USE WITH BRAIDED HOSES 2. IF USE WITH SPIRAL HOSES , HOSE FITTINGS SERIES NUMBER IS 20412C-XX-XX.

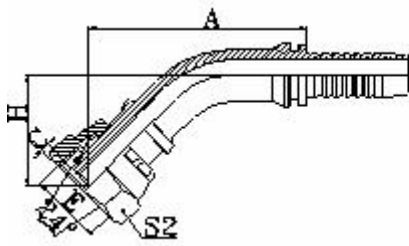

20441

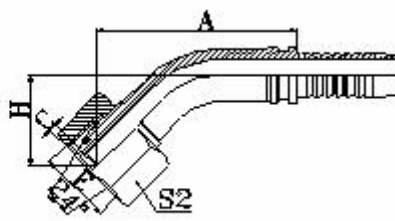

20441-T

45°公制内螺纹 24°锥带O形圈轻系列
ISO 12151-2-DIN 3865

45° METRIC FEMALE 24° CONE L.T.

代 号	螺纹E	软 管		管子外径	O 形圈	尺 寸			
		公称内径	标 号			A	C	H	S2
20441-12-04	M14X1.5	6	04	8	O06.5X1.5	45	2	26	19
20441-16-05	M16X1.5	8	05	10	O08.0X1.5	49.5	2	27.8	22
20441-16-06	M16X1.5	10	06	10	O08.0X1.5	51.3	2	27.8	22
20441-18-05T	M18X1.5	8	05	12	O10.0X1.5	44.7	1.5	23.2	22
20441-18-06	M18X1.5	10	06	12	O10.0X1.5	53	2.5	29	24
20441-22-05T	M22X1.5	8	05	15	O12.0X2		3		27
20441-22-06T	M22X1.5	10	06	15	O12.0X2	49	3	25.3	27
20441-22-08	M22X1.5	12	08	15	O12.0X2	66.5	2.5	34	27
20441-26-08T	M26X1.5	12	08	18	O15.0X2	61	2.1	28	32
20441-26-10	M26X1.5	16	10	18	O15.0X2	70	2.5	36	32
20441-26-12	M26X1.5	20	12	18	O15.0X2		2.5		32
20441-30-10T	M30X1.5	16	10	22	O20.0X2	64	3.8	30	36
20441-30-12	M30X1.5	20	12	22	O20.0X2	84.5	4	40.5	36
20441-36-12T	M36X1.5	20	12	28	O28.0X2	79.3	4.5	35.5	46
20441-36-14T	M36X2	22	14	28	O28.0X2		4.5		46
20441-45-20T	M45X2	32	20	35	O35.0X2	101.8	4	42.4	55
20441-52-20T	M52X2	32	20	42	O42.0X2		4	46.6	60
20441-52-24T	M52X2	40	24	42	O42.0X2	113	4		60

注: 1.上述代号用于编织软管。 2. 如需用于缠绕软管代号改为 20412-xx-xx。

NOTE : 1. FOR USE WITH BRAIDED HOSES 2. IF USE WITH SPIRAL HOSES , HOSE FITTINGS SERIES NUMBER IS 20412-XX-XX.

软管接头 HOSE FITTING

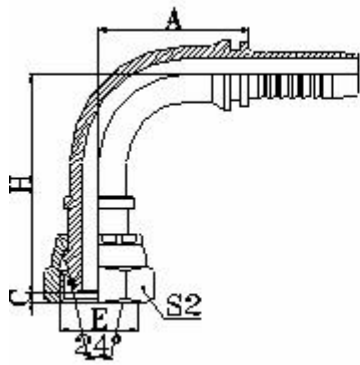

20491

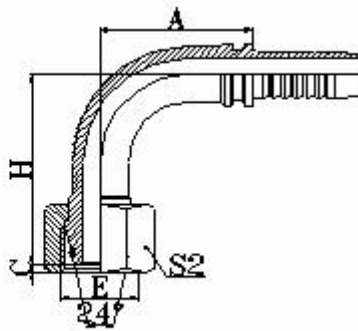

20491-T

90°公制内螺纹 24°锥带O形圈轻系列
ISO 12151-2-DIN 3865
90° METRIC FEMALE 24° CONE O-RING

代 号	螺纹E	软 管		管子外径	O 形圈	尺 寸			
		公称内径	标 号			A	C	H	S2
20491-12-03	M12X1.5	5	03	6	O04.5X1.5	25.6	1	34.5	17
20491-12-04	M12X1.5	6	04	6	O04.5X1.5	27.5	1	43	17
20491-14-04	M14X1.5	6	04	8	O06.5X1.5	27.5	2	44.5	19
20491-16-04	M16X1.5	6	04	10	O08.0X1.5	27.5	2	45	22
20491-16-05	M16X1.5	8	05	10	O08.0X1.5	31	2	49.5	22
20491-16-06	M16X1.5	10	06	10	O08.0X1.5	33	2	50.5	22
20491-18-05T	M18X1.5	8	05	12	O10.0X1.5	31	1.5	43	22
20491-18-06	M18X1.5	10	06	12	O10.0X1.5	33	2.5	52.5	24
20491-22-06T	M22X1.5	10	06	15	O12.0X2.0	33	3	47	27
20491-22-08	M22X1.5	12	08	15	O12.0X2.0	42.5	2.5	62.5	27
20491-26-08T	M26X1.5	12	08	18	O15.0X2.0	42.5	2.1	54.5	32
20491-26-10	M26X1.5	16	10	18	O15.0X2.0	48.5	2.5	68	32
20491-26-12	M26X1.5	20	12	18	O15.0X2.0	50.5	2.5	76	32
20491-30-10T	M30X2	16	10	22	O20.0X2.0	48.5	3.8	59.5	36
20491-30-12	M30X2	20	12	22	O20.0X2.0	50.5	4	78	36
20491-36-12T	M36X2	20	12	28	O26.0X2.0	50.5	4.5	71	46
20491-36-14T	M36X2	22	14	28	O26.0X2.0		4.5		46
20491-45-16T	M45X2	25	16	35	O32.0X2.5	66	4	83	55
20491-45-20T	M45X2	32	20	35	O32.0X2.5	75	4	95	55
20491-52-20T	M52X2	32	20	42	O38.0X2.5	75	4	96.5	60
20491-52-24T	M52X2	40	24	42	O38.0X2.5	89	4	108.5	60

注: 1.上述代号用于编织软管。 2. 如需用于缠绕软管代号改为 204922-xx-xx。

NOTE : 1. FOR USE WITH BRAIDED HOSES 2. IF USE WITH SPIRAL HOSES , HOSE FITTINGS SERIES NUMBER IS 20492XX-XX.

20491C

20491C-T

90° 公制内螺纹 24° 球面轻系列
90°METRIC FEMALE 24° CONE
MULTISEAL L.T.

代 号	螺纹E	软 管		管子外径	尺 寸			
		公称内径	标 号		A	C	H	S2
20491C-14-04	M14X1.5	6	04	8	30	3.5	39.5	19
20491C-16-04	M16X1.5	6	04	10	30	3.5	40	22
20491C-16-05	M16X1.5	8	05	10	33	3.5	43	22
20491C-16-06	M16X1.5	10	06	10	35.25	3.5	45.2	22
20491C-18-06	M18X1.5	10	06	12	35.25	3	47.25	24
20491C-22-08	M22X1.5	12	08	15	41	4.5	53	27
20491C-26-10	M26X1.5	16	10	18	56.5	4	60	32
20491C-30-12	M30X2	20	12	22	65.5	7	38.5	36
20491C-36-12T	M36X2	20	12	28	65.5	6.5	67.5	41

注: 1.上述代号用于编织软管。 2. 如需用于缠绕软管代号改为 20491C-xx-xx。

NOTE : 1. FOR USE WITH BRAIDED HOSES 2. IF USE WITH SPIRAL HOSES , HOSE FITTINGS SERIES NUMBER IS 20492C-XX-XX.

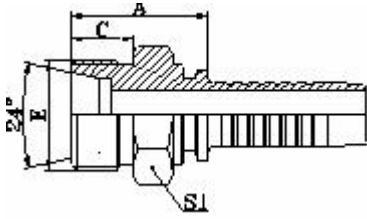

10511

公制外螺纹 24° 内锥面重系列

ISO-84341—DIN 3861

METRIC MALE 24° CONE SEAT H.T.

代 号	螺纹E	软 管		管子外径	尺 寸			
		公称内径	标 号		A	C	S1	
10511-14-04	M14X1.5	6	04	6	24	12	14	
10511-16-04	M16X1.5	6	04	8	24.5	12	17	
10511-18-04	M18X1.5	6	04	10	25	12	19	
10511-20-05	M20X1.5	8	05	12	26	12	22	
10511-20-06	M20X1.5	10	06	12	26	12	22	
10511-22-05	M22X1.5	8	05	14	28.5	14	24	
10511-22-06	M22X1.5	10	06	14	28.5	14	24	
10511-22-08	M22X1.5	12	08	14	29	14	24	
10511-24-08	M24X1.5	12	08	16	30	14	27	
10511-30-10	M30X2	16	10	20	35.5	16	32	
10511-30-12	M30X2	20	12	20	35.5	16	32	
10511-36-12	M36X2	20	12	25	38.5	18	38	
10511-36-16	M36X2	25	16	25	40	18	38	
10511-42-16	M42X2	25	16	30	43	20	46	
10511-42-20	M42X2	32	20	30	44	20	46	
10511-52-20	M52X2	32	20	38	48	22	55	

注: 1.上述代号用于编织软管。 2. 如需用于缠绕软管代号改为 20512-xx-xx。

NOTE : 1. FOR USE WITH BRAIDED HOSES 2. IF USE WITH SPIRAL HOSES , HOSE FITTINGS SERIES NUMBER IS 10512-XX-XX.

软管接头 HOSE FITTING

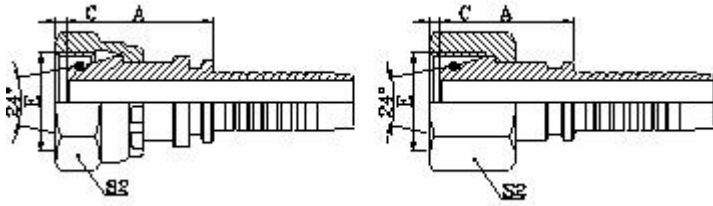

公制内螺纹
 锥带O形圈重系列
 ISO 12151-2—DIN 386
 METRIC FEMALE 24° CONE
 O-RING H.T.

20511

20511-T

代 号	螺纹E	软 管		管子外径	O 形圈	尺 寸		
		公称内径	标 号			A	C	S1
20511-14-04	M16X1.5	6	04	6	O04.5X1.5	27.4	1.5	19
20511-16-04	M16X1.5	6	04	8	O06.5X1.5	27.5	1.5	22
20511-16-05	M16X1.5	8	05	8	O06.5X1.5	27.5	1.5	22
20511-18-04T	M18X1.5	6	04	10	O08.0X1.5	26	1.5	22
20511-18-06	M18X1.5	10	06	10	O08.0X1.5	29.5	2	24
20511-20-06T	M20X1.5	10	06	12	O10.0X1.5	27.5	2.5	24
20511-20-08	M20X1.5	12	08	12	O10.0X1.5	31.5	2.5	27
20511-22-06T	M22X1.5	10	06	14	O11.0X2.0	28.5	3	27
20511-22-08	M22X1.5	12	08	14	O11.0X2.0	32.5	2.5	27
20511-24-06T	M24X1.5	10	06	16	O13.0X2.0	27	3	30
20511-24-08T	M24X1.5	12	08	16	O13.0X2.0	30	3	30
20511-30-10T	M30X2	16	10	20	O16.3X2.4	33.5	2.5	36
20511-30-12	M30X2	20	12	20	O16.3X2.4	37	3	36
20511-36-12T	M36X2	20	12	25	O20.3X2.4	37	3.2	46
20511-36-14T	M36X2	22	14	25	O20.3X2.4	37	3.2	46
20511-42-12T	M42X2	20	12	30	O25.3X2.4	37.5	3.9	50
20511-42-16T	M42X2	25	16	30	O25.3X2.4	41	3.9	50
20511-52-20T	M52X2	32	20	38	O33.3X2.4	44	4.5	60
20511-52-24T	M52X2	40	24	38	O33.3X2.4	44	4.5	60

注: 1.上述代号用于编织软管。 2. 如需用于缠绕软管代号改为 20512-xx-xx。

NOTE : 1. FOR USE WITH BRAIDED HOSES 2. IF USE WITH SPIRAL HOSES , HOSE FITTINGS SERIES NUMBER IS20512-XX-XX.

20511C 20511C-T

公制内螺纹 24° 球面重系列METRIC
FEMALE 24° MULTISEAL H.T.

代 号	螺纹E	软 管		管子外径	尺 寸			
		公称内径	标 号		A	C	S2	
20511C-18-04T	M18X1.5	6	04	10	21	3	22	
20511C-20-05T	M20X1.5	8	05	12	21.5	4.5	24	
20511C-20-06T	M20X1.5	10	06	12	21.5	4.5	24	
20511C-22-06T	M22X1.5	10	06	14	21.5	4.5	27	
20511C-24-08T	M24X1.5	12	08	16	23	5	30	
20511C-30-10T	M30X2	16	10	20	26.5	7	36	
20511C-36-12T	M36X2	20	12	25	27	6.5	41	
20511C-42-16T	M42X2	25	16	30	29.5	9	50	
20511C-52-20T	M52X2	32	20	38	34	8	60	

注: 1.上述代号用于编织软管。 2. 如需用于缠绕软管代号改为 20512C-xx-xx。

NOTE : 1. FOR USE WITH BRAIDED HOSES 2. IF USE WITH SPIRAL HOSES , HOSE FITTINGS
SERIES NUMBER IS20512C-XX-XX.

软管接头 HOSE FITTING

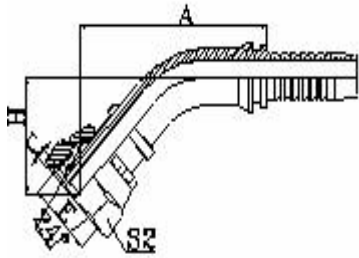

20541

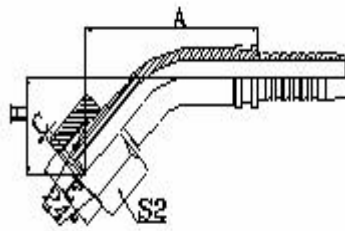

20541-T

45° 公制内螺纹
 24° 锥带O 形圈重系列
 ISO 12151-2-DIN
 45°METRIC FEMALE
 24°CONE O-RING H.T.

代 号	螺纹E	软 管		管子外径	O 形圈	尺 寸			
		公称内径	标 号			A	C	H	S2
20541-14-04	M16X1.5	6	04	6	O04.5X1.5	46	1.5	27	19
20541-16-04	M16X1.5	6	04	8	O06.5X1.5	46	1.5	27	22
20541-16-05	M16X1.5	8	05	8	O06.5X1.5	49.5	1.5	28.1	22
20541-18-04T	M18X1.5	6	04	10	O08.0X1.5	41.5	1.5	22.5	22
20541-18-06	M18X1.5	10	06	10	O08.0X1.5	53	2	29.5	24
20541-20-06T	M20X1.5	10	06	12	O10.0X1.5	48.5	2.5	25	24
20541-20-08	M20X1.5	12	08	12	O10.0X1.5	65.9	2.5	33	27
20541-22-06T	M22X1.5	10	06	14	O11.0X2.0	48.9	3	25.3	27
20541-22-08	M22X1.5	12	08	14	O11.0X2.0	66.5	2.5	34	27
20541-24-08T	M24X1.5	12	08	16	O13.0X2.0	61.3	3	28.5	30
20541-30-10T	M30X2	16	10	20	O16.3X2.4	64.5	2.5	30.8	36
20541-30-12	M30X2	20	12	20	O16.3X2.4	84.5	3	41	36
20541-36-12T	M36X2	20	12	25	O20.3X2.4	80	3.2	36	46
20541-36-14T	M36X2	22	14	25	O20.3X2.4		3.2		46
20541-42-16T	M42X2	25	16	30	O25.3X2.4	89.4	3.9	37.5	50
20541-52-20T	M52X2	32	20	38	O33.3X2.4	102	4.5	42.8	60
20541-52-24T	M52X2	40	24	38	O33.3X2.4		4.5		60

注: 1.上述代号用于编织软管。 2. 如需用于缠绕软管代号改为 20542-xx-xx。

NOTE : 1. FOR USE WITH BRAIDED HOSES 2. IF USE WITH SPIRAL HOSES , HOSE FITTINGS SERIES NUMBER IS20542-XX-XX.

20541C

20541C-T

45° 公制内螺纹 24° 球面系列DIN3868
45° METRIC FEMALE 24° MULTISEAL H.T.

代 号	螺纹E	软 管		管子外径	尺 寸			
		公称内径	标 号		A	C	H	S2
20541C-16-04	M16X1.5	6	04	8	44.8	3	22.7	19
20541C-18-04T	M18X1.5	6	04	10	43.7	3	21.6	22
20541C-20-06T	M20X1.5	10	06	12	48.9	4.5	24.6	24
20541C-24-08T	M24X1.5	12	08	16	61.4	2.5	26.5	30

注: 1.上述代号用于编织软管。 2. 如需用于缠绕软管代号改为 20542Cxx-xx。

NOTE : 1. FOR USE WITH BRAIDED HOSES 2. IF USE WITH SPIRAL HOSES , HOSE FITTINGS SERIES NUMBER IS20542C-XX-XX.

软管接头 HOSE FITTING

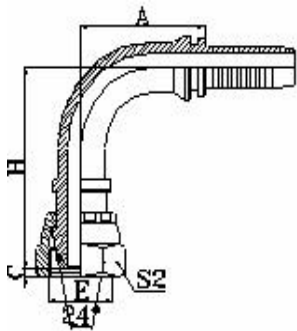

20591

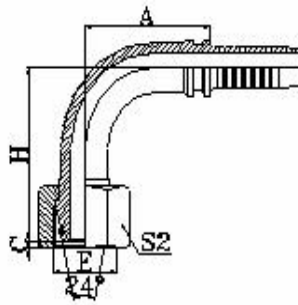

20591-T

90° 公制内螺纹
 24° 锥带O 形圈重系列
 ISO 12151-2-DIN 3865
 90°METRIC FEMALE 24°CONE
 O-RING H.T.

代 号	螺纹E	软 管		管子外径	O 形圈	尺 寸			
		公称内径	标 号			A	C	H	S 2
20591-14-04	M16X1.5	6	04	6	O04.5X1.5	27.5	1.5	45.4	19
20591-16-04	M16X1.5	6	04	8	O06.5X1.5	27.5	1.5	45.5	22
20591-16-05	M16X1.5	8	05	8	O06.5X1.5	31	1.5	50	22
20591-18-05T	M18X1.5	8	05	10	O08.0X1.5	31	1.5	43.5	22
20591-18-06	M18X1.5	10	06	10	O08.0X1.5	33	2	53	24
20591-20-06T	M20X1.5	10	06	12	O10.0X1.5	33	2.5	46.5	24
20591-20-08	M20X1.5	12	08	12	O10.0X1.5	42.5	2.5	61.5	27
20591-22-06T	M22X1.5	10	06	14	O11.0X2.0	33	3	47	27
20591-22-08	M22X1.5	12	08	14	O11.0X2.0	42.5	2.5	62.5	27
20591-24-08T	M24X1.5	12	08	16	O13.0X2.0	42.5	3	55	30
20591-24-10	M24X1.5	16	10	16	O13.0X2.0	48.5	2.5	68	30
20591-30-10T	M30X2	16	10	20	O16.3X2.4	48.5	2.5	60.5	36
20591-30-12	M30X2	20	12	20	O16.3X2.4	50.5	3	78.5	36
20591-36-12T	M36X2	20	12	25	O20.3X2.4	50.5	3.2	72	46
20591-36-14T	M36X2	22	14	25	O20.3X2.4	57.5	3.2	74	46
20591-42-16T	M42X2	25	16	30	O25.3X2.4	66	3.9	83	50
20591-52-20T	M52X2	32	20	38	O33.3X2.4	75	4.5	95.5	60
20591-52-24T	M52X2	40	24	38	O33.3X2.4	93	4.5	107.5	60

注: 1.上述代号用于编织软管。 2. 如需用于缠绕软管代号改为 20592-xx-xx。

NOTE : 1. FOR USE WITH BRAIDED HOSES 2. IF USE WITH SPIRAL HOSES , HOSE FITTINGS SERIES NUMBER IS 20592-XX-XX.

20591C 20591C-T

90° 公制内螺纹 24° 球面重系列
90° METRIC FEMALE 24° MULTISEAL H.T.

代 号	螺纹E	软 管		管子外径	尺 寸			
		公称内径	标 号		A	C	H	S2
20591C-16-04	M16X1.5	6	04	8	30	3	40	22
20591C-18-04T	M18X1.5	6	04	10	30	3	38.5	22
20591C-20-05T	M20X1.5	8	05	12	33	4.5	42	24
20591C-20-06T	M20X1.5	10	06	12	35.3	4.5	45.7	24
20591C-22-06T	M22X1.5	10	06	14	35.3	4.5	44.7	27
20591C-24-08T	M24X1.5	12	08	16	41	5	52	30
20591C-30-10T	M30X2	16	10	20	56.5	7	56.5	36
20591C-36-12T	M36X2	20	12	25	65.5	6.5	66.5	41
20591C-42-16T	M42X2	25	16	30	78	9	73.5	50
20591C-52-20T	M52X2	32	20	38	93	8	87.5	60

注: 1.上述代号用于编织软管。 2. 如需用于缠绕软管代号改为 20592C-xx-xx。
NOTE : 1. FOR USE WITH BRAIDED HOSES 2. IF USE WITH SPIRAL HOSES , HOSE FITTINGS SERIES NUMBER IS20592C-XX-XX.

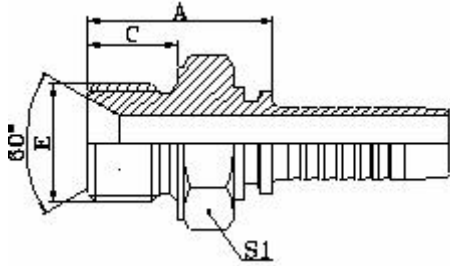

10611

公制外螺纹 60° 内锥面或六角编面
用组合垫密封的双用接头

METRIC MALE DOUBLE USE FOR 60°

代 号	螺纹E	软 管		尺 寸			
		公称内径	标 号	A	C	S1	
10611-14-04	M14X1.5	6	04	23.5	11	19	
10611-14-06	M14X1.5	10	06	25	11	19	
10611-16-04	M16X1.5	6	04	27.5	12	22	
10611-16-05	M16X1.5	8	05	27.5	12	22	
10611-18-06	M18X1.5	10	06	29.5	12	24	
10611-22-06	M22X1.5	10	06	30.5	14	27	
10611-22-08	M22X1.5	12	08	31	14	27	
10611-24-10	M24X1.5	16	10	35	14	30	
10611-26-10	M26X1.5	16	10	35	16	32	
10611-27-10D	M27X1.5	16	10	35	16	32	
10611-27-10	M27X1.5	16	10	37	18	32	
10611-30-12D	M30X2	20	12	38	18	36	
10611-30-12	M30X2	20	12	38	18	36	
10611-33-16	M33X2	25	16	43	20	46	
10611-42-20	M42X2	32	20	46	20	50	
10611-45-20	M45X2	32	20	46	20	55	
10611-48-24	M48X2	40	24	46	20	55	
10611-52-24	M52X2	40	24	46	20	60	

注: 1.上述代号用于编织软管。 2. 如需用于缠绕软管代号改为 10612xx-xx。

NOTE : 1. FOR USE WITH BRAIDED HOSES 2. IF USE WITH SPIRAL HOSES , HOSE FITTINGS SERIES NUMBER IS 10612-XX-XX.

软管接头 HOSE FITTING

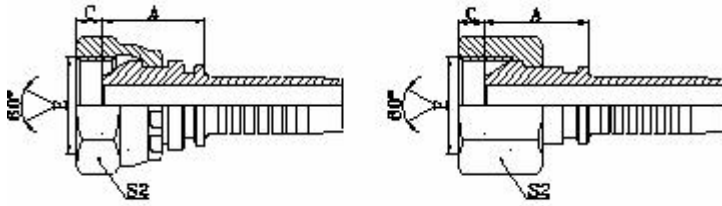

公制外内螺纹 60°
METRIC FEMALE 60°CONE

20611

20611-T

代 号	螺纹E	软 管		尺 寸			
		公称内径	标 号	A	C	S2	
20611-14-04	M14X1.5	6	04	19	5.5	19	
20611-16-05	M16X1.5	8	05	19.5	5.5	22	
20611-16-06	M16X1.5	10	06	19	5.5	22	
20611-18-06	M18X1.5	10	06	21	5.5	24	
20611-20-08	M20X1.5	12	08	22	6.5	27	
20611-22-08	M22X1.5	12	08	23.5	6	27	
20611-24-10	M24X1.5	16	10	24.5	6.5	30	
20611-26-10	M26X1.5	16	10	25	6	32	
20611-27-10DT	M27X1.5	16	10	25.5	6	32	
20611-27-10T	M27X1.5	16	10	25.5	6	32	
20611-30-10D	M30X2	16	10	26.5	6	36	
20611-30-12D	M30X2	20	12	26.5	6	36	
20611-30-12	M30X2	20	12	27	6	36	
20611-36-16	M36X2	25	16	30	6.5	41	
20611-39-16T	M39X2	25	16	30	6.5	46	
20611-45-20T	M45X2	32	20	31	8.5	55	
20611-52-24T	M52X2	40	24	32	10	60	

注: 1.上述代号用于编织软管。 2. 如需用于缠绕软管代号改为 20612-xx-xx。

NOTE : 1. FOR USE WITH BRAIDED HOSES 2. IF USE WITH SPIRAL HOSES , HOSE FITTINGS SERIES NUMBER IS20612-XX-XX.

软管接头 HOSE FITTING

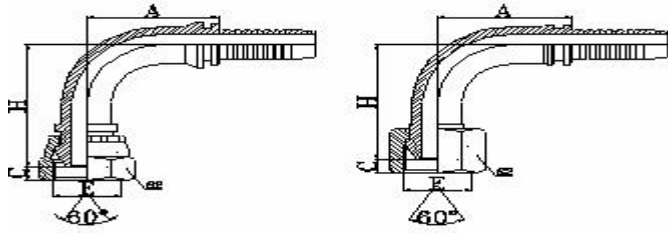

90° 公制外内螺纹 60° 外锥面
90°METRIC FEMALE 60°CONE

20691

20691-T

代 号	螺纹E	软 管		尺 寸			
		公称内径	标 号	A	C	H	S2
20611-14-04	M14X1.5	6	04	27.5	5.5	37	19
20611-16-05	M16X1.5	8	05	31	5.5	42	22
20611-18-06	M18X1.5	10	06	33	5.5	44.5	24
20611-22-08	M22X1.5	12	08	42.5	6	53.5	27
20611-27-10DT	M27X1.5	16	10	56	6	55	32
20611-30-12D	M30X2	20	12	66.2	6	68.5	36
20611-36-16	M36X2	25	16	78	6.5	76.5	41
20611-36-14T	M36X2	22	14	71.2	6.5	67.5	41
20611-39-16T	M39X2	25	16	76.7	6.5	74	46
20611-45-20T	M45X2	32	20	91.5	8.5	85	55
20611-52-24T	M52X2	40	24	109.4	10	99	60

注: 1.上述代号用于编织软管。 2. 如需用于缠绕软管代号改为 20692-xx-xx。

NOTE : 1. FOR USE WITH BRAIDED HOSES 2. IF USE WITH SPIRAL HOSES , HOSE FITTINGS SERIES NUMBER IS20692-XX-XX.

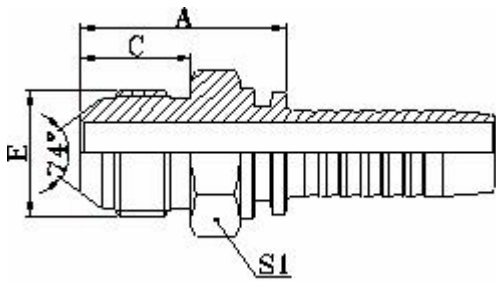

10711

国际公制外螺纹 74° 外锥面

METRIC MALE 74° CONE

代 号	螺纹E	软 管			尺 寸			
		公称内径	标 号		A	C	S1	
10711-10-02	M10X1	4	02		23	12.5	14	
10711-10-03	M10X1	5	03		23	12.5	14	
10711-12-03	M12X1.5	5	03		26.5	15.7	14	
10711-12-03C	M12X1.25	5	03		24.5	14	14	
10711-14-04	M14X1.5	6	04		30.5	18	17	
10711-14-06	M14X1.5	10	06		30.5	18	17	
10711-16-05	M16X1.5	8	05		31.5	19	17	
10711-16-06	M16X1.5	10	06		31.5	19	17	
10711-18-06	M18X1.5	10	06		32	19	19	
10711-22-08	M22X1.5	12	08		34.5	19.5	24	
10711-24-08	M24X1.5	12	08		36.5	20	27	
10711-27-10	M27X1.5	16	10		39	20.5	30	
10711-30-12	M30X2	20	12		42.5	23	32	
10711-30-12E	M30X2	20	12		45.5	26	32	
10711-33-12	M33X2	20	12		46.5	26	36	
10711-36-14	M36X2	22	14		47	26	38	
10711-39-16	M39X2	25	16		50	27.5	41	
10711-42-20	M42X2	32	20		52.5	28.5	46	
10711-45-20	M45X2	32	20		52.5	28.5	46	

注: 1.上述代号用于编织软管。 2. 如需用于缠绕软管代号改为 10712-xx-xx。

NOTE : 1. FOR USE WITH BRAIDED HOSES 2. IF USE WITH SPIRAL HOSES , HOSE FITTINGS SERIES NUMBER IS10712-XX-XX.

软管接头 HOSE FITTING

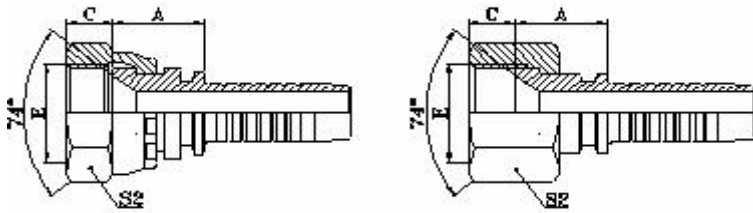

国际公制内螺纹 74° 内锥
METRIC FEMALE 74° CONE SEAT

20711

20711-T

代 号	螺纹E	软 管		尺 寸			
		公称内径	标 号	A	C	S2	
20711-10-02	M10X1	4	02	14	7.5	14	
20711-12-03C	M12X1.25	5	03	14	9	17	
20711-12-03	M12X1.5	5	03	14	10	17	
20711-12-04	M12X1.5	6	04	15	10	17	
20711-14-04	M14X1.5	6	04	16	8.5	19	
20711-14-05	M14X1.5	8	05	15.5	8.5	19	
20711-14-06	M14X1.5	10	06	15.5	8.5	19	
20711-16-04	M16X1.5	6	04	16.5	8	22	
20711-16-05	M16X1.5	8	05	17	8	22	
20711-16-06	M16X1.5	10	06	16	8	22	
20711-18-05T	M18X1.5	8	05	16	8	22	
20711-18-06	M18X1.5	10	06	18.5	10	24	
20711-20-06T	M20X1.5	10	06	16	10	24	
20711-20-08	M20X1.5	12	08	18.5	10	27	
20711-22-06T	M22X1.5	10	06	16	10	27	
20711-22-08	M22X1.5	12	08	19.5	10	27	
20711-22-10	M22X1.5	16	10	19	10	27	
20711-24-08T	M24X1.5	12	08	16.5	11	30	
20711-27-08T	M27X1.5	12	08	18.5	11	32	
20711-27-10T	M27X1.5	16	10	21	11	32	
20711-27-12	M27X1.5	20	12	21.5	11	32	
20711-30-10T	M30X1.5	16	10	18	11	36	
20711-30-12	M30X1.5	20	12	22	11	36	
20711-33-10T	M33X2	16	10	19.5	13	41	
20711-33-12T	M33X2	20	12	20	13	41	
20711-33-14	M33X2	22	14	21.5	13	41	
20711-36-12T	M36X2	20	12	20	14	41	
20711-36-14T	M36X2	22	14	24	14	41	
20711-36-16	M36X2	25	16	23	14	41	
20711-39-16T	M39X2	25	16	25	14	46	
20711-42-16T	M42X2	25	16	23.5	15	50	
20711-42-20W	M42X2	32	20	24.5	15	50	
20711-45-20T	M45X2	32	20	27	15	55	
20711-52-24T	M52X2	40	24	27	17	60	

注: 1.上述代号用于编织软管。 2. 如需用于缠绕软管代号改为 20712-xx-xx。

NOTE : 1. FOR USE WITH BRAIDED HOSES 2. IF USE WITH SPIRAL HOSES , HOSE FITTINGS SERIES NUMBER IS 20712-XX-XX.

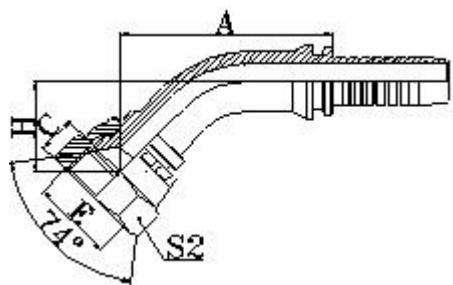

20741

45° 国际公制内螺纹 74° 内锥面
45°METRIC FEMALE 74°CONE SEAT

代 号	螺纹E	软 管		尺 寸			
		公称内径	标 号	A	C	H	S2
20741-14-04	M14X1.5	6	04	38	8.5	19	19
20741-16-05	M16X1.5	8	05	42.3	8	20.7	22
20741-18-06	M18X1.5	10	06	45.5	10	22	24
20741-22-08	M22X1.5	12	08	57.5	10	24.5	27
20741-27-10	M27X1.5	16	10	60	11	26.5	32
20741-30-12	M30X1.5	20	12	74	11	30	36
20741-33-12	M33X2	20	12	77.4	13	30	41
20741-33-16	M33X2	25	16	85	13	30.8	41
20741-36-14	M36X2	22	14	79.8	14	29.6	4
20741-36-16	M36X2	25	16	85.7	14	31.5	41
20741-39-16	M39X2	25	16	85	14	33	46
20741-45-20W	M45X2	32	20	97	15	36.2	55
20741-52-24W	M52X2	40	24	115.3	17	40.9	60

注: 1.上述代号用于编织软管。 2. 如需用于缠绕软管代号改为 20742-xx-xx。

NOTE : 1. FOR USE WITH BRAIDED HOSES 2. IF USE WITH SPIRAL HOSES , HOSE FITTINGS SERIES NUMBER IS 20742-XX-XX.

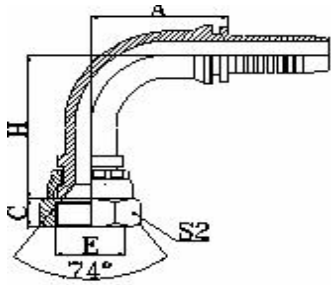

20791

90° 国际公制内螺纹 74° 内锥面
90°METRIC FEMALE 74°CONE SEAT

代 号	螺纹E	软 管		尺 寸			
		公称内径	标 号	A	C	H	S2
20791-12-04C	M12X1.25	6	04	30	9	33.5	17
20791-12-04	M12X1.5	6	04	30	10	33.5	17
20791-14-04	M14X1.5	6	04	27.5	8.5	34	19
20791-16-04	M16X1.5	6	04	30	8	35	22
20791-16-05	M16X1.5	8	05	31	8	39.5	22
20791-18-06	M18X1.5	10	06	33	10	42	24
20791-22-08	M22X1.5	12	08	42.5	10	49.5	27
20791-22-10	M22X1.5	16	10	56	10	52.5	27
20791-27-10	M27X1.5	16	10	48.5	11	54.5	32
20791-30-12	M30X1.5	20	12	50.5	11	63.5	36
20791-33-12	M33X2	20	12	65.5	13	63.5	41
20791-33-16	M33X2	25	16	66	13	75.5	41
20791-36-12	M36X2	20	12	65.5	124	63.5	41
20791-36-14	M36X2	22	14	71.2	14	64.5	41
20791-39-16	M39X2	25	16	66	14	76.5	46
20791-45-20W	M45X2	32	20	91.5	15	83	55
20791-52-20W	M52X2	32	20	93	17	84.5	60
20791-52-24W	M52X1.5	40	24	110.7	17	96.5	60

注: 1.上述代号用于编织软管。 2. 如需用于缠绕软管代号改为 20792-xx-xx。

NOTE : 1. FOR USE WITH BRAIDED HOSES 2. IF USE WITH SPIRAL HOSES , HOSE FITTINGS SERIES NUMBER IS 20792-XX-XX.

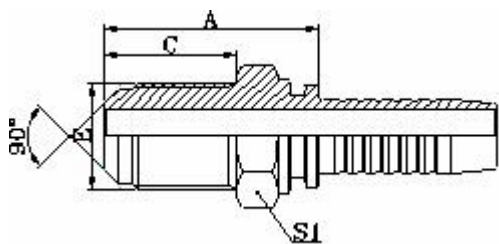

10811L

公制外螺纹 90° 外锥面

METRIC MALE 90°CONE

代 号	螺纹E	软 管		尺 寸			
		公称内径	标 号	A	C	H	S2
10811L-12-04	M12X1.5	6	04	46	34	17	17
10811L-12-04A	M12X1	6	04	44.5	32.5	17	17
10811L-14-04	M14X1.5	6	04	46	34	17	19
10811L-14-06	M14X1.5	10	06	46.5	34	17	19
10811L-16-04	M16X1.5	6	04	46.5	34	19	22
10811L-16-06	M16X1.5	10	06	46.5	34	22	22
10811L-20-06	M20X1.5	10	06	57	40	27	27
10811L-20-08	M20X1.5	12	08	57.5	40	27	27
10811L-22-08	M22X1.5	12	08	62.5	45	27	27

软管接头 HOSE FITTING

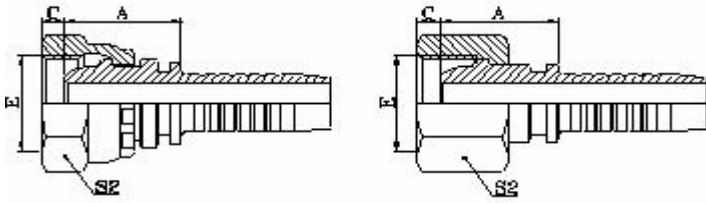

公制内螺纹球面

METRIC FEMALE MULTISEAL

20111

20111-T

代 号	螺纹E	软 管		尺 寸			
		公称内径	标 号	A	C	S2	
20111-10-03	M10X1	5	03	18	2.5	14	
20111-10-04	M10X1	6	04	18	2.5	14	
20111-12-04	M12X1.5	6	04	18.5	4	17	
20111-12-05	M12X1.5	8	05	18.5	4	17	
20111-14-04	M14X1.5	6	04	20	4.5	19	
20111-14-05	M14X1.5	8	05	19.5	4.5	19	
20111-16-04	M16X1.5	6	04	20.5	4.5	22	
20111-16-05	M16X1.5	8	05	20.5	4.5	22	
20111-16-06	M16X1.5	10	06	20	4.5	22	
20111-18-05T	M18X1.5	8	05	21.5	4	24	
20111-18-06	M18X1.5	10	06	22.5	4	24	
20111-18-08	M18X1.5	12	08	22	4	24	
20111-20-06T	M20X1.5	10	06	23.5	5.5	24	
20111-20-08	M20X1.5	12	08	23	5.5	27	
20111-22-06T	M22X1.5	10	06	23	5	27	
20111-22-08	M22X1.5	12	08	24.5	5	27	
20111-22-10	M22X1.5	16	10	24.5	5	27	
20111-24-08T	M24X1.5	12	08	22	5.5	30	
20111-24-10	M24X1.5	16	10	26	5	30	
20111-27-08DT	M27X1.5	12	08	23	5.5	32	
20111-27-10DT	M27X1.5	16	10	26	5.5	32	
20111-27-12D	M27X1.5	20	12	26	5.5	32	
20111-27-10T	M27X2	16	10	26	7	32	
20111-30-12D	M30X1.5	20	12	26.5	6	36	
20111-30-12	M30X2	20	12	26	7	36	
20111-36-12T	M36X2	20	12	26	7	41	
20111-36-14T	M36X2	22	14	26	7	41	
20111-39-14T	M39X2	22	14	28.5	7	46	
20111-39-16T	M39X2	25	16	34	7	46	
20111-42-16T	M42X2	25	16	30	8.5	50	
20111-45-20T	M45X2	32	20	31.5	8.5	55	
20111-52-20T	M52X2	32	20	33	9	60	
20111-52-24T	M52X2	40	24	33	9	60	
20111-64-32T	M64X2	50	32	35	14	75	

注: 1.上述代号用于编织软管。 2. 如需用于缠绕软管代号改为 20112-xx-xx。

NOTE : 1. FOR USE WITH BRAIDED HOSES 2. IF USE WITH SPIRAL HOSES , HOSE FITTINGS SERIES NUMBER IS 20112-XX-XX.

软管接头 HOSE FITTING

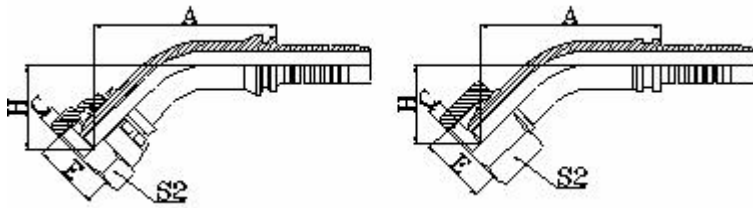

45° 公制内螺纹球面
45° METRIC FEMALE MULTISEAL

20141

20141-T

代 号	螺纹E	软 管		尺 寸			
		公称内径	标 号	A	C	H	S2
20141-10-03	M10X1	5	03	41.1	2.5	20.7	14
20141-10-04	M10X1	6	04	43.2	2.5	21.5	14
20141-12-03	M12X1.5	5	03	40.9	4	21.2	17
20141-12-04	M12X1.5	9	04	43	4	22	17
20141-14-04	M14X1.5	6	04	43.4	4.5	21.3	19
20141-14-05	M14X1.5	8	05	45.5	4.5	22.2	19
20141-16-04	M16X1.5	6	04	44.7	4.5	23.2	22
20141-16-05	M16X1.5	8	05	45.8	4.5	22.5	22
20141-16-06	M16X1.5	10	06	47.4	4.5	24.1	22
20141-18-05T	M18X1.5	8	05	46.8	4	22.6	24
20141-18-06	M18X1.5	10	06	48.5	4	24.2	24
20141-18-08	M18X1.5	12	08	52.2	4	25.7	24
20141-20-06T	M20X1.5	10	06	48.2	5.5	23.9	27
20141-20-08	M20X1.5	12	08	62.1	5.5	27.2	27
20141-22-06T	M22X1.5	10	06	58.4	5	25.7	27
20141-22-08	M22X1.5	12	08	62.1	5	27.2	27
20141-24-08T	M24X1.5	12	08	61.1	5.5	26.1	30
20141-24-10	M24X1.5	16	10	75.4	5	29.6	30
20141-27-10DT	M27X1.5	16	10	74.4	5.5	29.6	32
20141-27-10T	M27X2	16	10	74.4	5.5	29.6	32
20141-30-12D	M30X1.5	20	12	80.9	6	33.5	36
20141-30-12	M30X2	20	12	80.9	6	33.5	36
20141-36-14T	M36X2	22	14	83	7	32.64	41
20141-39-16T	M39X2	25	16	88.2	7	33.95	46
20141-45-20T	M45X2	32	20	99.1	8.5	38.4	55
20141-52-24T	M52X2	40	24	114.1	9	43.4	60

注: 1.上述代号用于编织软管。 2. 如需用于缠绕软管代号改为 20142-xx-xx。

NOTE : 1. FOR USE WITH BRAIDED HOSES 2. IF USE WITH SPIRAL HOSES , HOSE FITTINGS SERIES NUMBER IS 20142-XX-XX.

软管接头 HOSE FITTING

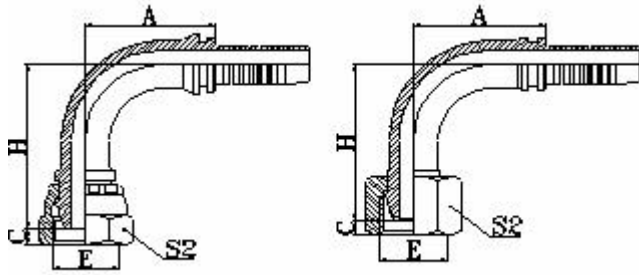

90° 公制内螺纹球面
90° METRIC FEMALE MULTISEAL

20191

20191-T

代 号	螺纹E	软 管		尺 寸			
		公 称 内 径	标 号	A	C	H	S2
20191-10-03	M10X1	5	03	27	2.5	35.5	14
20191-12-04	M12X1.5	6	04	30	4	37.5	17
20191-14-04	M14X1.5	6	04	27.5	4.5	38	19
20191-14-05	M14X1.5	8	05	33	4.5	41	19
20191-16-04	M16X1.5	6	04	27.5	4.5	38.5	19
20191-16-05	M16X1.5	8	05	31	4.5	43	22
20191-16-06	M16X1.5	10	06	35.3	4.5	43.8	22
20191-18-05T	M18X1.5	8	05	31	4	43	24
20191-18-06	M18X1.5	10	06	35.3	4	45.3	24
20191-18-08	M18X1.5	12	08	40.5	4	50.5	24
20191-20-06T	M20X1.5	10	06	35.3	5.5	43.8	24
20191-20-08	M20X1.5	12	08	41	5.5	52	27
20191-22-06T	M22X1.5	10	06	35.8	5	76.8	27
20191-22-08	M22X1.5	12	08	42.5	5	54.5	27
20191-24-08T	M24X1.5	12	08	41	5.5	51	30
20191-24-10	M24X1.5	16	10	58	5	58.5	30
20191-27-10DT	M27X1.5	16	10	56	5.5	55.5	32
20191-27-10T	M27X2	16	10	56	5.5	55.5	32
20191-30-12D	M30X1.5	20	12	67.5	6	68.5	36
20191-30-12	M30X2	20	12	67.5	6	68.5	36
20191-36-12T	M36X2	20	12	65.5	7	68	41
20191-36-14T	M36X2	22	14	71.2	7	69	4
20191-39-16T	M39X2	25	16	76.7	7	73.5	14
20191-45-20T	M45X2	32	20	91.5	8.5	85	655
20191-52-24T	M52X2	40	24	109.4	9	100	60
20191-64-32T	M64X2	50	32	131.75	14	122.3	75

注: 1.上述代号用于编织软管。 2. 如需用于缠绕软管代号改为 20192-xx-xx。

NOTE : 1. FOR USE WITH BRAIDED HOSES 2. IF USE WITH SPIRAL HOSES , HOSE FITTINGS SERIES NUMBER IS 20192-XX-XX.

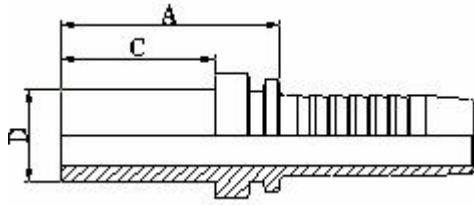

50011
公制卡套式直管
DIN2353
METRIC STANDPIPE STRAIGHT

代 号	管子外径D	软 管		尺 寸			备 注
		公称内径	标 号	A	C		
50011-06-03	6	5	03	28.5	22		轻系列
50011-06-04	6	6	04	29	22		
50011-10-05	10	8	05	31	23		
50011-10-06	10	10	06	32	23		
50011-12-06	12	10	06	32.5	23		
50011-12-08	12	12	08	33	23		
50011-15-06	15	10	06	35.5	25		
50011-15-08	15	12	08	35.5	25		
50011-18-08	18	12	08	36.5	26		
50011-18-10	18	16	10	41	26		
50011-22-10	22	16	10	44	28		
50011-22-12	22	20	12	44	28		
50011-22-16	22	25	16	46	28		
50011-28-16	28	25	16	47	30		
50011-35-20	35	32	20	56	36		
50011-42-24	42	40	24	62	40		
50011-08-04	8	6	04	31	24		重系列
50011-08-05	8	8	05	33	24		
50011-08-06	8	10	06	33	24		
50011-10-04	10	6	04	33	26		
50011-12-04	12	6	04	34.5	26		
50011-12-05	12	8	05	35.5	26		
50011-14-06	14	10	06	39.5	29		
50011-14-08	14	12	08	40	29		
50011-14-12	14	20	12	45.5	29		
50011-16-08	16	12	08	40.5	30		
50011-16-10	16	16	10	45.5	30		
50011-20-10	20	16	10	52	36		
50011-20-12	20	20	12	52.5	36		
50011-25-12	25	20	12	56	40		
50011-25-16	25	25	16	57	40		
50011-30-16	30	25	16	63	44		
50011-30-20	30	32	20	64	44		
50011-38-16	38	25	16	69	50		
50011-38-20	38	32	20	70	50		

注: 1.上述代号用于编织软管。 2. 如需用于缠绕软管代号改为 50012-xx-xx。

NOTE : 1. FOR USE WITH BRAIDED HOSES 2. IF USE WITH SPIRAL HOSES , HOSE FITTINGS SERIES NUMBER IS 50012-XX-XX.

软管接头 HOSE FITTING

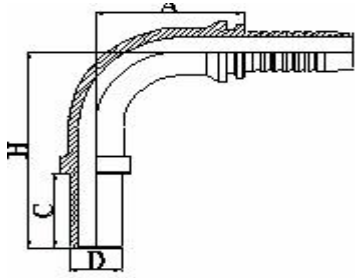

50091 90° 公制卡套式直管 90° METRIC STANDPIPE STRAIGHT DIN2353

代 号	管子外径 D	软 管		尺 寸			备 注
		公称内径	标 号	A	C	H	
50091-06-03	6	5	03	26.5	22	42.5	轻系列
50091-06-04	6	6	04	30	22	45.5	
50091-08-05	8	8	05	33	24	50.5	
50091-08-06	8	10	06	35.3	24	52.8	
50091-10-05	10	8	05	33	23	49.5	
50091-10-06	10	10	06	35.3	23	51.8	
50091-12-06	12	10	06	35.36	23	53.8	
50091-12-08	12	12	08	41	23	59	
50091-15-06	15	10	06	35.3	25	53.8	
50091-15-08	15	12	08	41	25	59	
50091-18-08	18	12	08	41	26	60	
50091-18-10	18	16	10	56.5	26	64.5	
50091-22-10	22	16	10	56.5	28	66.5	
50091-22-12	22	20	12	65.5	28	76	
50091-22-16	22	25	16	76.7	28	81.5	
50091-28-16	28	25	16	76.7	30	83.5	
50091-35-20	35	32	20	93	36	100.5	重系列
50091-08-04	8	6	04	30	24	47.5	
50091-10-04	10	6	04	30	26	49.5	
50091-12-04	12	6	04	30	26	49.5	
50091-12-05	12	8	05	33	26	52.5	
50091-14-06	14	10	06	35.3	29	57.8	
50091-14-08	14	12	08	41	29	63	
50091-16-08	16	12	08	41	30	64	
50091-16-10	16	16	10	56.5	30	68.5	
50091-20-10	20	16	10	56.5	36	74.5	
50091-20-12	20	20	12	65.5	36	85	
50091-25-12	25	20	12	65.5	40	89	
50091-25-16	25	25	16	76.7	40	93.5	
50091-30-16	30	25	16	76.7	40	93.5	
50091-30-20	30	32	20	91.5	44	108.5	
50091-38-16	38	25	16	76.7	50	115.5	
50091-38-20	38	32	20	91.5	50	114.5	

注: 1. 上述代号用于编织软管。 2. 如需用于缠绕软管代号改为 50092-xx-xx。

NOTE : 1. FOR USE WITH BRAIDED HOSES 2. IF USE WITH SPIRAL HOSES , HOSE FITTINGS SERIES NUMBER IS50092-XX-XX.

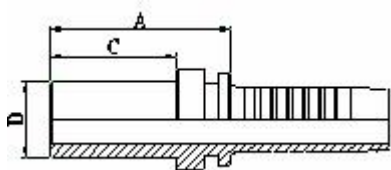

51011

国际卡套式直管

BSP STANDARD PIPE

代 号	管子外径D	软 管		尺 寸			
		公称内径	标 号		A	C	
51011-04-03	4	5			27	17	
51011-06-03	6	5			30.5	19	
51011-06-04	6	6			31	19	
51011-08-04	8	6			31	19	
51011-08-05	8	8			31.5	19	
51011-08-06	8	10			32	19	
51011-10-04	10	6			35	22	
51011-10-05	10	8			35	22	
51011-10-06	10	10			35	22	
51011-12-05	12	8			35	22	
51011-12-06	12	10			35	22	
51011-14-06	14	10			35	22	
51011-14-08	14	12			35.5	22	
51011-16-06	16	10			35	22	
51011-16-08	16	12			36	22	
51011-16-10	16	16			36.5	22	
51011-16-12	16	20			38	22	
51011-18-12	18	20			41.5	24	
51011-22-12	22	20			45	28	
51011-22-14	22	22			45	28	
51011-28-16	28	25			49	30	
51011-34-20	34	32			53	33	
51011-42-24	42	40			57	35	

注: 1.上述代号用于编织软管。 2. 如需用于缠绕软管代号改为 51012-xx-xx。

NOTE : 1. FOR USE WITH BRAIDED HOSES 2. IF USE WITH SPIRAL HOSES , HOSE FITTINGS SERIES NUMBER IS51012-XX-XX.

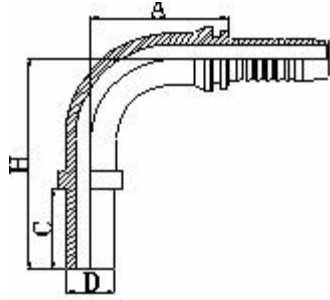

51091

90° 国际卡套式直管

90°BSP STANDARD PIPE

代 号	管子外径D	软 管		尺 寸			
		公称内径	标 号		A	C	H
51091-06-04	6	6	04		30.5	19	42.5
51091-06-06	6	10	06		35.3	19	47.8
51091-08-04	8	6	04		30	19	42.5
51091-08-05	8	8	05		33	19	45.5
51091-10-04	10	6	04		30	22	45.5
51091-10-06	10	10	06		35.8	22	50.8
51091-12-06	12	10	06		35.3	22	50.8
51091-12-08	12	12	08		41	22	56
51091-14-06	14	10	06		35.3	22	50.8
51091-14-08	14	12	08		41	22	56
51091-15-10	15	16	10		56.5	26	64.5
51091-16-08	16	12	08		42	22	56
51091-16-10	16	16	10		56.5	22	60.5
51091-18-10	18	16	10		56.5	24	62.5
51091-18-12	18	20	12		64.9	24	72
51091-22-14	22	22	14		71.2	28	77
51091-28-16	28	25	16		76.7	30	83.5
51091-34-20	34	32	20		91.5	33	97.5
51091-42-24	42	40	24		109.4	35	113

注: 1.上述代号用于编织软管。 2. 如需用于缠绕软管代号改为 51092-xx-xx。

NOTE : 1. FOR USE WITH BRAIDED HOSES 2. IF USE WITH SPIRAL HOSES , HOSE FITTINGS SERIES NUMBER IS 51092-XX-XX.

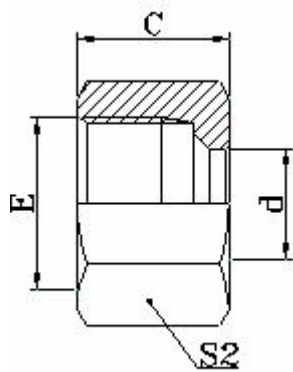

NL

NS

RETAINING NUT L.T.

卡套螺母

代 号	螺纹E	管子外径		尺 寸			压力等级 MPa
				C	D	S2	
NL-12	M12X1.5	6		14.5	6	14	轻系列 L
NL-14	M14X1.5	8		14.5	8	17	
NL-16	M16X1.5	10		15.5	10	19	
NL-18	M18X1.5	12		15.5	12	22	
NL-22	M22X1.5	15		17	15	27	
NL-26	M26X1.5	18		18	18	32	
NL-30	M30X2	22		20	22	36	
NL-30D	M30X1.5	22		19	22	36	
NL-36	M36X2	28		21	28	41	
NL-36D	M36X1.5	28		21	28	41	
NL-45	M45X2	35		24	35	50	
NL-45D	M45X1.5	35		25	35	50	
NL-52	M52X2	42		24	42	60	
NS-14	M14X1.5	6		16.5	6	17	
NS-16	M16X1.5	8		16.5	8	19	
NS-18	M18X1.5	10		17.5	10	22	
NS-20	M20X1.5	12		17.5	12	24	
NS-22	M22X1.5	14		20.5	14	27	
NS-24	M24X1.5	16		20.5	16	30	
NS-30	M30X2	20		24	20	36	
NS-36	M36X2	25		27	25	46	
NS-42	M42X2	30		29	30	50	
NS-52	M52X2	38		32.5	38	60	

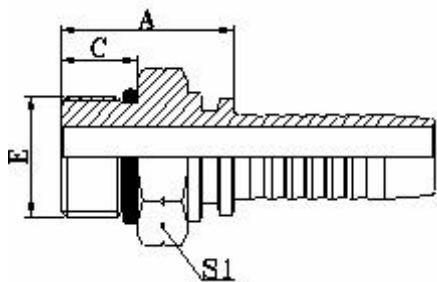

12211

BSP MALE O-RING SEAL

英管外螺纹O形圈密封

代 号	管子外径D	软 管		O 形圈	尺 寸		
		公称内径	标 号		A	C	H
12211-04-04	G1/4"X19	6	04		24	11	19
12211-04-06	G1/4"X19	10	06		23.5	11	19
12211-06-06	G3/8"X19	10	06		26	12	22
12211-08-04	G1/2"X14	6	04		33.5	14	27
12211-08-06	G1/2"X14	10	06		33.5	14	27
12211-08-08	G1/2"X14	12	08		30	14	27
12211-10-10	G5/8"X14	16	10		34	15.5	30
12211-12-10	G3/4"X14	16	10		35	15.5	32
12211-12-12	G3/4"X14	20	12		35	15.5	32
12211-12-16	G3/4"X14	25	16		36	15.5	32
12211-16-16	G1"X11	25	16		41	18.5	41
12211-20-20	G1.1/4"X11	32	20		45	20	50

注: 1.上述代号用于编织软管。 2. 如需用于缠绕软管代号改为 12212-xx-xx。

NOTE : 1. FOR USE WITH BRAIDED HOSES 2. IF USE WITH SPIRAL HOSES , HOSE FITTINGS SERIES NUMBER IS 12212-XX-XX.

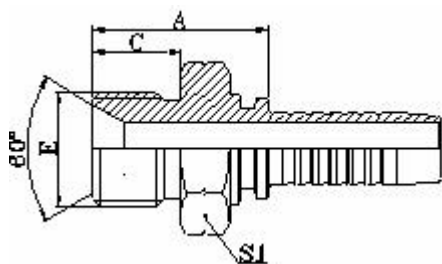

12611

BSP MALE 60° CONE SEAT

英管外螺纹 60° 内锥面

代 号	管子外径D	软 管		尺 寸			
		公称内径	标 号	A	C	S1	
12611-02-03	G1/8"X28	5	03	22	10	12	
12611-04-04	G1/4"X19	6	04	24	12	14	
12611-06-05	G3/8"X19	8	05	26	13.5	17	
12611-06-06	G3/8"X19	10	06	26	13.5	17	
12611-06-08	G3/8"X19	12	08	26.5	13.5	19	
12611-08-06	G1/2"X14	10	06	30.5	16	22	
12611-08-08	G1/2"X14	12	08	30.5	16	22	
12611-10-08	G5/8"X14	12	08	32.5	17.5	24	
12611-10-10	G5/8"X14	16	10	34	17.5	24	
12611-12-08	G3/4"X14	12	08	35.5	18.5	27	
12611-12-10	G3/4"X14	16	10	37	18.5	27	
12611-12-12	G3/4"X14	20	12	36	18.5	27	
12611-16-12	G1"X11	20	12	40.5	20.5	36	
12611-16-16	G1"X11	25	16	42.5	20.5	36	
12611-20-16	G1.1/4"X11	25	16	43.5	20.5	46	
12611-20-20	G1.1/4"X11	32	20	44.5	20.5	46	
12611-24-20	G1.1/2"X11	32	20	49	23	50	
12611-24-24	G1.1/2"X11	40	24	49	23	50	
12611-32-32	G2"X11	50	32	54.5	25.5	65	

注: 1.上述代号用于编织软管。 2. 如需用于缠绕软管代号改为 12612-xx-xx。

NOTE : 1. FOR USE WITH BRAIDED HOSES 2. IF USE WITH SPIRAL HOSES , HOSE FITTINGS SERIES NUMBER IS12612-XX-XX.

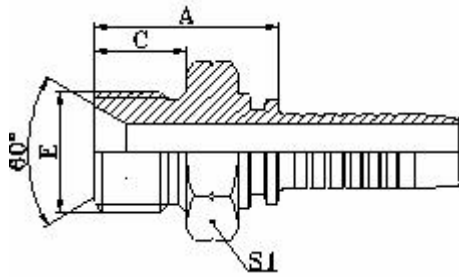

12611A

英管外螺纹 60° 内锥面或六角端面
用组合垫密封的双用接头

BSP MALE DOUBLE USE FOR 60° CONE SEAT
OR BONDED SEAL

代 号	管子外径D	软 管		尺 寸			
		公称内径	标 号	A	C	S1	
12611A-02-03	G1/8"X28	5	03	22	10	14	
12611A-04-04	G1/4"X19	6	04	25	12	19	
12611A-04-05	G3/8"X19	8	05	25	12	19	
12611A-06-05	G3/8"X19	8	05	26	13.5	22	
12611A-06-06	G3/8"X19	10	06	27.5	13.5	22	
12611A-06-08	G3/8"X19	12	08	28.5	13.5	22	
12611A-08-06	G1/2"X14	10	06	33	16	27	
12611A-08-08	G1/2"X14	12	08	32	16	27	
12611A-08-10	G1/2"X14	16	10	32	16	27	
12611A-10-08	G5/8"X14	12	08	35	17.5	30	
12611A-10-10	G5/8"X14	16	10	36	17.5	30	
12611A-12-08	G3/4"X14	12	08	36.5	18.5	32	
12611A-12-10	G3/4"X14	16	10	37.5	18.5	32	
12611A-12-12	G3/4"X14	20	12	38	18.5	32	
12611A-16-12	G1"X11	20	12	42.5	20.5	41	
12611A-16-16	G1"X11	25	16	43	20.5	41	
12611A-20-16	G1.1/4"X11	25	16	45.5	20.5	50	
12611A-20-20	G1.1/4"X11	32	20	45.5	20.5	50	
12611A-24-24	G1.1/2"X11	40	24	50	23	55	
12611A-32-32	G2"X11	50	32	54.5	25.5	70	

注: 1. 上述代号用于编织软管。 2. 如需用于缠绕软管代号改为 12612A-xx-xx。

NOTE : 1. FOR USE WITH BRAIDED HOSES 2. IF USE WITH SPIRAL HOSES , HOSE FITTINGS
SERIES NUMBER IS 12612A-XX-XX.

软管接头 HOSE FITTING

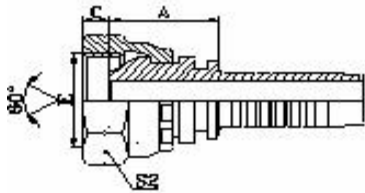

22611

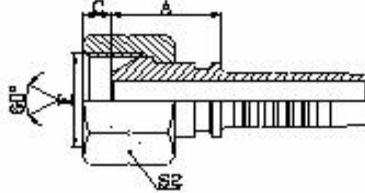

22611-T

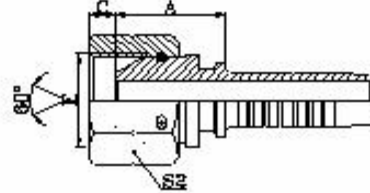

22611-W

英管内螺纹 60° 外锥面

BSP FEMALE 60° CONE

代 号	管子外径D	软 管		尺 寸			
		公称内径	标 号	A	C	S2	
22611-02-03	G1/8"X28	5	03	15	5.5	14	
22611-02-04	G1/8"X28	6	04	17.5	5.5	14	
22611-04-03	G1/4"X19	5	03	17	5.5	19	
22611-04-04	G1/4"X19	6	04	19	5.5	19	
22611-04-05	G1/4"X19	8	05	19	5.5	19	
22611-04-06	G1/4"X19	10	06	19	5.5	19	
22611-06-04	G3/8"X19	6	04	21	6.3	22	
22611-06-05	G3/8"X19	8	05	21	6.3	22	
22611-06-06	G3/8"X19	10	06	21	6.3	22	
22611-06-08	G3/8"X19	12	08	21.5	6.3	22	
22611-08-06T	G1/2"X14	10	06	21	7.5	27	
22611-08-08	G1/2"X14	12	08	23	7.5	27	
22611-10-08	G5/8"X14	12	08	23.5	9.5	30	
22611-10-10	G5/8"X14	16	10	24.5	9.5	30	
22611-12-08T	G3/4"X14	12	08	22	10.9	32	
22611-12-10	G3/4"X14	16	10	24.5	10.9	32	
22611-12-12	G3/4"X14	20	12	24.5	10.9	32	
22611-16-12T	G1"X11	20	12	24	11.7	41	
22611-16-14	G1"X11	22	14	26	11.7	41	
22611-16-16	G1"X11	25	16	27.5	11.7	41	
22611-20-16T	G1.1/4"X11	25	16	27.5	11	50	
22611-20-20W	G1.1/4"X11	32	20	30.5	11	50	
22611-24-20T	G1.1/2"X11	32	20	32	13	55	
22611-24-24W	G1.1/2"X11	40	24	32	13	55	
22611-32-24T	G2"X11	40	24	30	16	70	
22611-32-32W	G2"X11	50	32	31.9	16	70	

注: 1.上述代号用于编织软管。 2. 如需用于缠绕软管代号改为 22612-xx-xx。

NOTE : 1. FOR USE WITH BRAIDED HOSES 2. IF USE WITH SPIRAL HOSES , HOSE FITTINGS SERIES NUMBER IS 22612-XX-XX.

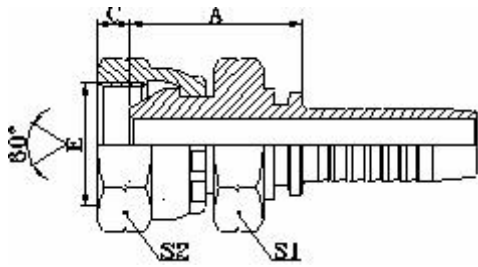

22611D

英管内螺纹 60° 外锥面双六角

BSP FEMALE 60° CONE DOUBLE HEXAGON

代 号	管子外径D	软 管		尺 寸			
		公称内径	标 号	A	C	S1	S2
22611D-04-04	G1/4"X19	6	04	24.5	5.5	19	19
22611D-06-06	G3/8"X19	10	06	27	6.3	22	22
22611D-08-08	G1/2"X14	12	08	30.5	7.5	27	27
22611D-10-08	G5/8"X14	12	08	31	9.5	30	30
22611D-12-08	G3/4"X14	12	08	31.5	10.9	32	32
22611D-12-12	G3/4"X14	20	12	34.5	10.9	32	32
22611D-16-16	G1"X11	25	16	38.5	11.7	41	41
22611D-20-20W	G1.1/4"X11	32	20	44	11	50	50

注: 1.上述代号用于编织软管。 2. 如需用于缠绕软管代号改为 22612D-xx-xx。

NOTE : 1. FOR USE WITH BRAIDED HOSES 2. IF USE WITH SPIRAL HOSES , HOSE FITTINGS SERIES NUMBER IS 22612D-XX-XX.

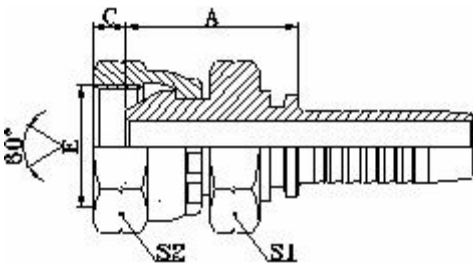

22611D-SM

英管内螺纹 60° 外锥面双六角

BSP FEMALE 60° CONE DOUBLE HEXAGON

代 号	管子外径D	软 管		尺 寸			
		公称内径	标 号	A	C	S1	S2
22611D-04-04SM	G1/4"X19	6	04	23.5	5.5	12	19
22611D-06-06SM	G3/8"X19	10	06	24.5	6.3	17	22
22611D-08-08SM	G1/2"X14	12	08	29	7.5	22	27
22611D-10-08SM	G5/8"X14	12	08	29	9.5	22	30
22611D-12-08SM	G3/4"X14	12	08	31.5	10.9	27	32
22611D-12-12SM	G3/4"X14	20	12	33.5	10.9	27	32
22611D-16-16SM	G1"X11	25	16	35.5	11.7	32	41
22611D-20-20SM	G1.1/4"X11	32	20	42	11	41	50

注: 1.上述代号用于编织软管。 2. 如需用于缠绕软管代号改为 22612D-xx-xxSM。

NOTE : 1. FOR USE WITH BRAIDED HOSES 2. IF USE WITH SPIRAL HOSES , HOSE FITTINGS SERIES NUMBER IS 22612D-XX-XXSM.

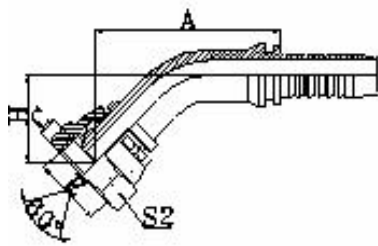

22641

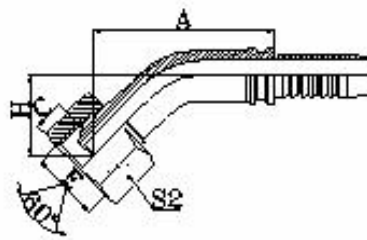

22641-T

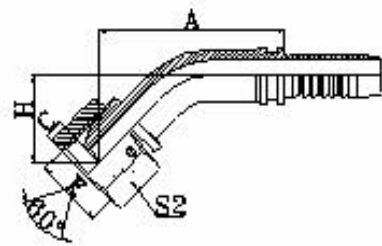

22641-W

45° 英管内螺纹 60° 外锥面

45°BSP FEMALE 60°CONE

代 号	管子外径D	软 管		尺 寸			
		公称内径	标 号	A	C	H	S2
22641-04-04	G1/4"X19	6	04	40	5.5	21	19
22641-06-04	G3/8"X19	6	04	43.2	6.3	21	22
22641-06-05	G3/8"X19	8	05	45.3	6.3	22	22
22641-06-06	G3/8"X19	10	06	47	6.3	24	22
22641-08-06T	G1/2"X14	10	06	48.1	7.5	23.9	27
22641-08-08	G1/2"X14	12	08	59.5	7.5	27	27
22641-10-08	G5/8"X14	12	08	61.4	9.5	26.5	30
22641-10-10	G5/8"X14	16	10	63	9.5	29	30
22641-12-08T	G3/4"X14	12	08	61.8	10.9	26.9	32
22641-12-10	G3/4"X14	16	10	63	10.9	29	32
22641-12-12	G3/4"X14	20	12	75.5	10.9	32	32
22641-16-12T	G1"X11	20	12	80.8	11.7	33.4	41
22641-16-16	G1"X11	25	16	86	11.7	34	41
22641-20-16T	G1.1/4"X11	25	16	85.3	11	31.1	50
22641-20-20W	G1.1/4"X11	32	20	98.8	11	38	50
22641-24-24W	G1.1/2"X11	40	24	116.8	13	45.5	55
22641-32-32W	G2"X11	50	32	135.7	16	52.7	70

注: 1.上述代号用于编织软管。 2. 如需用于缠绕软管代号改为 22642-xx-xx。

NOTE : 1. FOR USE WITH BRAIDED HOSES 2. IF USE WITH SPIRAL HOSES , HOSE FITTINGS SERIES NUMBER IS 22642-XX-XX.

软管接头 HOSE FITTING

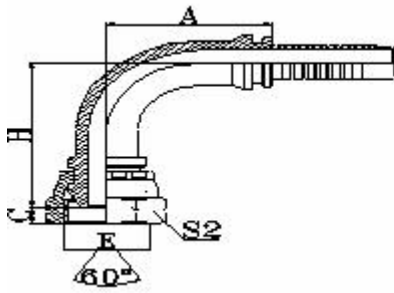

22691

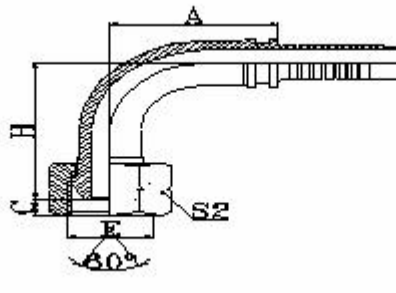

22691-T

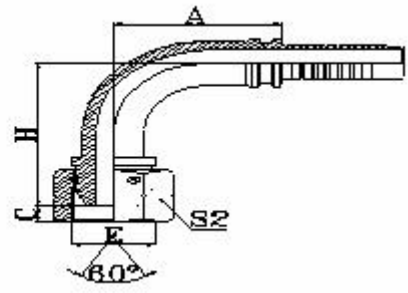

22691-W

90° 英管内螺纹 60° 外锥面

90°BSP FEMALE 60°CONE

代 号	管子外径D	软 管		尺 寸			
		公称内径	标 号	A	C	H	S2
22691-02-03	G1/8"X28	5	03	26.5	5.5	31.5	14
22691-02-04	G1/8"X28	6	04	27.5	5.5	35.5	14
22691-04-03	G1/4"X19	5	03	26.5	5.5	33.5	19
22691-04-04	G1/4"X19	6	04	27.5	5.5	37	19
22691-04-05	G1/4"X19	8	05	31	5.5	41.5	19
22691-04-06	G1/4"X19	10	06	30	5.5	36.5	19
22691-06-04	G3/8"X19	6	04	27.5	6.3	39	22
22691-06-05	G3/8"X19	8	05	31	6.3	43.5	22
22691-06-06	G3/8"X19	10	06	33	6.3	44.5	22
22691-08-06T	G1/2"X14	10	06	35.3	7	43.3	27
22691-08-08	G1/2"X14	12	08	42.5	7.5	53	27
22691-08-10	G1/2"X14	16	10	56.5	7.5	55.5	27
22691-10-08	G5/8"X14	12	08	42.5	9.5	53.5	30
22691-10-10	G5/8"X14	16	10	48.5	9.5	58	30
22691-12-08T	G3/4"X14	12	08	41	10.9	52.1	32
22691-12-10	G3/4"X14	16	10	48.5	10.9	58	32
22691-12-12	G3/4"X14	20	12	50.5	10.9	66	32
22691-16-12T	G1"X11	20	12	65.5	11.7	68.3	41
22691-16-14	G1"X11	22	14	71.2	11.7	69.3	41
22691-16-16	G1"X11	25	16	66	11.7	78.5	41
22691-20-16T	G1.1/4"X11	25	16	78	11	69.5	50
22691-20-20W	G1.1/4"X11	32	20	91.5	11	84.3	50
22691-24-24W	G1.1/2"X11	40	24	109.4	13	103	55
22691-32-32W	G2"X11	50	32	131.8	16	123.3	70

注: 1.上述代号用于编织软管。 2. 如需用于缠绕软管代号改为 22692-xx-xx。

NOTE : 1. FOR USE WITH BRAIDED HOSES 2. IF USE WITH SPIRAL HOSES , HOSE FITTINGS SERIES NUMBER IS 22692-XX-XX.

22691 K

BSP FEMALE CONE DOUBLE HEXAGON

90° 英管短身内螺纹 60° 外锥面

代 号	管子外径D	软 管		尺 寸				
		公称内径	标 号	A	C	H	S1	S2
22691K-04-04	G1/4"X19	6	04	17.5	5.5	18.5	11	19
22691K-06-04	G3/8"X19	6	04	20	6.3	24	16	22
22691K-06-05	G3/8"X19	8	05	20	6.3	24	16	22
22691K-06-06	G3/8"X19	10	06	20	6.3	24	16	22
22691K-08-06	G1/2"X14	10	06	23	7.5	28.5	19	27
22691K-08-08	G1/2"X14	12	08	23.5	7.5	28.5	19	27
22691K-10-10	G5/8"X14	16	10	24.5	9.5	30.5	22	30
22691K-12-12	G3/4"X14	20	12	27.5	10.9	33	27	32
22691K-16-16	G1"X11	25	16	43	11.7	38.5	33	41

注: 1.上述代号用于编织软管。 2. 如需用于缠绕软管代号改为 22692K-xx-xx。

NOTE : 1. FOR USE WITH BRAIDED HOSES 2. IF USE WITH SPIRAL HOSES , HOSE FITTINGS SERIES NUMBER IS 22692K-XX-XX.

软管接头 HOSE FITTING

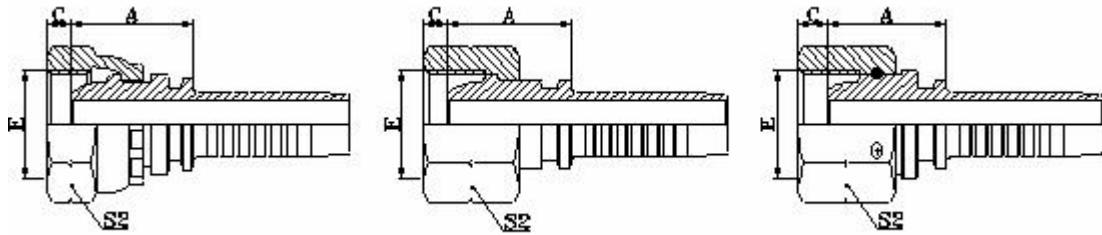

22111

22111-T

22111-W

英管内螺纹球面

BSP FEMALE MULTISEAL

代 号	螺纹E	软 管		尺 寸			
		公称内径	标 号	A	C	S2	
22111-02-04	G1/8"X28	6	04	19	2	14	
22111-04-03	G1/4"X19	5	03	19	4	19	
22111-04-04	G1/4"X19	6	04	20.5	4	19	
22111-06-05	G3/8"X19	8	05	20	5	22	
22111-06-06	G3/8"X19	10	06	22.5	5	22	
22111-06-08	G3/8"X19	12	08	21	5	22	
22111-08-06T	G1/2"X14	10	06	22.5	6	27	
22111-08-08	G1/2"X14	12	08	25.5	6	27	
22111-08-10	G1/2"X14	16	10	24	6	27	
22111-10-10	G5/8"X14	16	10	26	8	30	
22111-10-12	G5/8"X14	20	12	25	8	30	
22111-12-08T	G3/4"X14	12	08	25	9.5	32	
22111-12-10	G3/4"X14	16	10	26	9.5	32	
22111-12-12	G3/4"X14	20	12	26	9.5	32	
22111-16-12T	G1"X11	20	12	26.5	11	41	
22111-16-14	G1"X11	22	14	26.5	11	41	
22111-16-16	G1"X11	25	16	28.5	11	41	
22111-20-16T	G1.1/4"X11	25	16	27.5	11	50	
22111-20-20W	G1.1/4"X11	32	20	31.5	10	50	
22111-24-24W	G1.1/2"X11	40	24	37	11.5	55	
22111-32-32W	G2"X11	50	32	34	15	70	

注: 1.上述代号用于编织软管。 2. 如需用于缠绕软管代号改为 22212-xx-xx。

NOTE : 1. FOR USE WITH BRAIDED HOSES 2. IF USE WITH SPIRAL HOSES , HOSE FITTINGS SERIES NUMBER IS 22212-XX-XX.

软管接头 HOSE FITTING

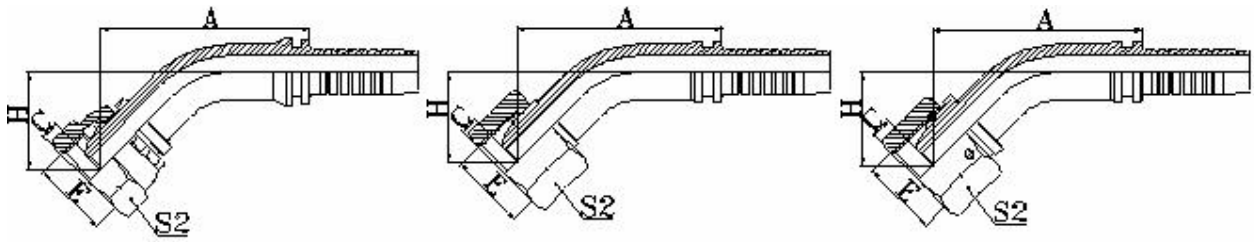

22141

22141-T

22141-W

45° 英管内螺纹球面

45°BSP FEMALE MULTISEAL

代 号	螺纹E	软 管		尺 寸			
		公称内径	标 号	A	C	H	S2
22141-02-04	G1/8"X28	6	04	43.7	2	21.6	14
22141-04-03	G1/4"X19	5	03	41.3	4	20.4	19
22141-04-04	G1/4"X19	6	04	43.7	4	21.6	19
22141-06-05	G3/8"X19	8	05	46.2	5	22.9	22
22141-06-06	G3/8"X19	10	06	48.1	5	23.9	22
22141-06-08	G3/8"X19	12	08	60.4	5	25.4	22
22141-08-04T	G1/2"X14	6	04	43.9	6	23.8	27
22141-08-06T	G1/2"X14	10	06	42.5	6	18.2	27
22141-08-08	G1/2"X14	12	08	61.8	6	26.8	27
22141-08-10	G1/2"X14	16	10	73	6	29	27
22141-10-10	G5/8"X14	16	10	73.7	8	28.9	30
22141-10-12	G5/8"X14	20	12	79.8	8	32.5	30
22141-12-08T	G3/4"X14	12	08	63.2	9.5	28.3	32
22141-12-10	G3/4"X14	16	10	70.4	9.5	29.6	32
22141-12-12	G3/4"X14	20	12	80.6	9.5	33.2	32
22141-16-12	G1"X11	20	12	81.6	11	33.5	41
22141-16-14	G1"X11	22	14	83.3	11	33	41
22141-16-16	G1"X11	25	16	89.2	11	35	41
22141-20-16T	G1.1/4"X11	25	16	91.4	9.1	37.1	50
22141-20-20W	G1.1/4"X11	32	20	102.9	10	41.2	50
22141-24-24W	G1.1/2"X11	40	24	119.8	11.5	49	55
22141-32-32W	G2"X11	50	32	137.4	15	53	70

注: 1.上述代号用于编织软管。 2. 如需用于缠绕软管代号改为 22142-xx-xx。

NOTE : 1. FOR USE WITH BRAIDED HOSES 2. IF USE WITH SPIRAL HOSES , HOSE FITTINGS SERIES NUMBER IS22142-XX-XX.

软管接头 HOSE FITTING

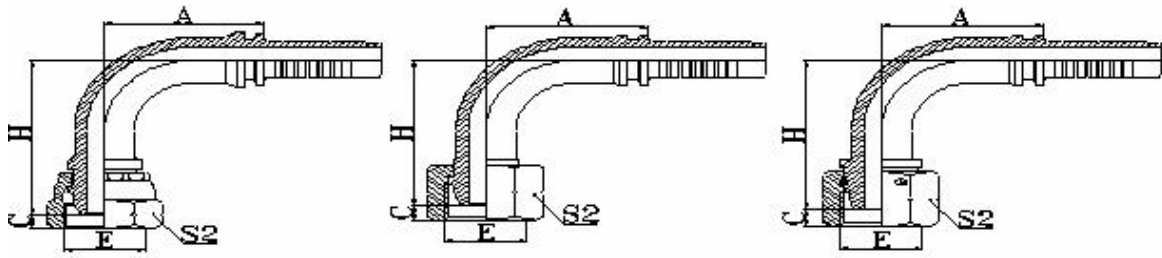

22191

22191-T

22191-W

90° 英管内螺纹球面

90°BSP FEMALE MULTISEAL

代 号	螺纹E	软 管		尺 寸			
		公称内径	标 号	A	C	H	S2
22191-02-04	G1/8"X28	6	04	30	2	38	14
22191-04-03	G1/4"X19	5	03	27	4	35	19
22191-04-04	G1/4"X19	6	04	30	4	38	19
22191-04-05	G1/4"X19	8	05	33	4	41.5	19
22191-06-05	G3/8"X19	8	05	33	5	42	22
22191-06-06	G3/8"X19	10	06	35.3	5	44.3	22
22191-06-08	G3/8"X19	12	08	41	5	50	22
22191-08-06T	G1/2"X14	10	06	35.3	6	46.8	27
22191-08-08	G1/2"X14	12	08	41	6	52.5	27
22191-10-10	G5/8"X14	16	10	56.5	8	57.5	30
22191-10-12	G5/8"X14	20	12	65.5	8	67	30
22191-12-08T	G3/4"X14	12	08	41	9.5	52	32
22191-12-10	G3/4"X14	16	10	56.5	9.5	58.5	32
22191-12-12	G3/4"X14	20	12	65.5	9.5	68	32
22191-16-12T	G1"X11	20	12	66.2	11	68.5	41
22191-16-14	G1"X11	22	14	71.2	11	69.5	41
22191-16-16	G1"X11	25	16	76.7	11	75	41
22191-20-16T	G1.1/4"X11	25	16	76.7	10	78	50
22191-20-20W	G1.1/4"X11	32	20	92.3	10	85.3	50
22191-24-24W	G1.1/2"X11	40	24	109.4	11.5	108	55
22191-32-32W	G2"X11	50	32	133.1	15	123.8	70

注: 1.上述代号用于编织软管。 2. 如需用于缠绕软管代号改为 22192-xx-xx。

NOTE : 1. FOR USE WITH BRAIDED HOSES 2. IF USE WITH SPIRAL HOSES , HOSE FITTINGS SERIES NUMBER IS 22192-XX-XX.

软管接头 HOSE FITTING

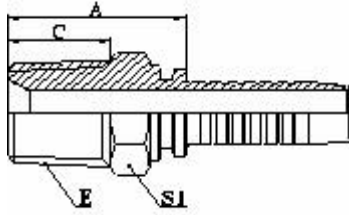

13011-SP

英锥管外螺纹

BSP MALE

代 号	螺纹E	软 管		尺 寸			
		公称内径	标 号	A	C	S1	
13011-02-03SP	R1/8"X28	5	03	22	10	12	
13011-02-04SP	R1/8"X28	6	04	22.5	10	12	
13011-04-04SP	R1/4"X19	6	04	27	14.5	14	
13011-04-05SP	R1/4"X19	8	05	25	15.4	14	
13011-04-06SP	R1/4"X19	10	06	27	14.5	17	
13011-06-04SP	R3/8"X19	6	04	27.5	15	17	
13011-06-05SP	R3/8"X19	8	05	26.5	15	17	
13011-06-06SP	R3/8"X19	10	06	27.5	15	17	
13011-06-08SP	R3/8"X19	12	08	30	15	19	
13011-08-06SP	R1/2"X14	10	06	34.5	20	22	
13011-08-08SP	R1/2"X14	12	08	35	20	22	
13011-08-10SP	R1/2"X14	16	10	38	20	22	
13011-08-12SP	R1/2"X14	20	12	38	20	27	
13011-12-08SP	R3/4"X14	12	08	37	20	27	
13011-12-10SP	R3/4"X14	16	10	38	20	27	
13011-12-12SP	R3/4"X14	20	12	38.5	20	27	
13011-12-16SP	R3/4"X14	25	16	39.5	20	32	
13011-16-12SP	R1"X11	20	12	44	25.5	36	
13011-16-16SP	R1"X11	25	16	45	25.5	36	
13011-20-20SP	R1.1/4"X11	32	20	49.5	26.5	46	
13011-24-24SP	R1.1/2"X11	40	24	52.5	26.5	50	
13011-32-24SP	R2"X11	40	24	57	30	65	
13011-32-32SP	R2"X11	50	32	59	30	65	

注: 1.上述代号用于编织软管。 2. 如需用于缠绕软管代号改为 13012-xx-xxSP。

NOTE : 1. FOR USE WITH BRAIDED HOSES 2. IF USE WITH SPIRAL HOSES , HOSE FITTINGS SERIES NUMBER IS 13012-XX-XXSP.

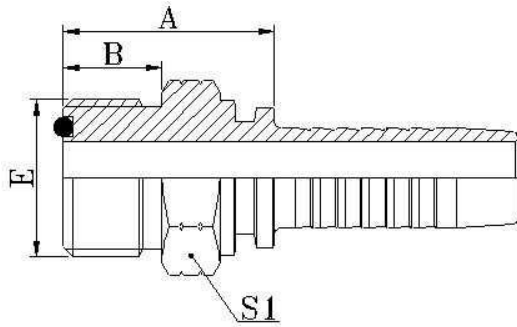

14211

美制ORFS 外螺纹平面O 形圈

ISO 8434-3—SAE J1453

ORFS MALE O-RING SEAL

代 号	螺纹E	软 管		O 形圈	尺 寸			
		公称内径	标 号		A	C	S1	
14211-04-04	9/16"X18	6	04	O011	22.3	9.8	17	
14211-06-04	11/16"X16	6	04	O012	24.2	11.2	19	
14211-06-06	11/16"X16	10	06	O012	24.2	11.2	19	
14211-08-06	13/16"X16	10	06	O014	26.8	12.8	22	
14211-08-08	13/16"X16	12	08	O014	27.3	12.8	22	
14211-08-10	13/16"X16	16	10	O014	28.5	12.8	22	
14211-10-08	1"X14	12	08	O016	31.5	15.5	27	
14211-10-10	1"X14	16	10	O016	33	15.5	27	
14211-12-08	1.3/16"X12	12	08	O018	36.5	17	32	
14211-12-10	1.3/16"X12	16	10	O018	36	17	32	
14211-12-12	1.3/16"X12	20	12	O018	36.5	17	32	
14211-16-12	1.7/16"X12	20	12	O021	37	17.5	38	
14211-16-16	1.7/16"X12	25	16	O021	39.5	17.5	38	
14211-20-20	1.11/16"X12	32	20	O025	41.5	17.5	46	
14211-24-24	2"X12	40	24	O029	44.5	17.5	55	

注: 1.上述代号用于编织软管。 2. 如需用于缠绕软管代号改为 14212-xx-xx。
 NOTE : 1. FOR USE WITH BRAIDED HOSES 2. IF USE WITH SPIRAL HOSES , HOSE FITTINGS SERIES NUMBER IS 14212-XX-XX.

软管接头 HOSE FITTING

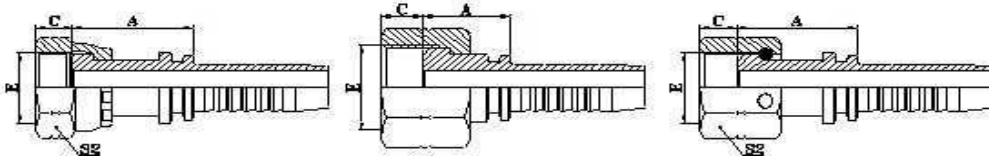

24211

24211-T

24211-W

美制ORFS 内螺纹平面
ORFS FEMALE FLAT SEAT
ISO 12151-1—SAE J516

代 号	螺纹E	软 管		尺 寸			
		公称内径	标 号	A	H	S2	
24211-04-04	9/16"X18	6	04	25.5	8.5	19	
24211-04-05	9/16"X18	8	05	22.5	8.5	19	
24211-04-06	9/16"X18	10	06	22.5	8.5	19	
24211-06-04T	11/16"X16	6	04	23.5	10	22	
24211-06-05T	11/16"X16	8	05	23.5	10	22	
24211-06-06	11/16"X16	10	06	26.5	10	22	
24211-06-08	11/16"X16	12	08	26	10	22	
24211-08-05T	13/16"X16	8	05	25	11	27	
24211-08-06T	13/16"X16	10	06	24.5	11	27	
24211-08-08	13/16"X16	12	08	28	11	27	
24211-08-10	13/16"X16	16	10	29	11	27	
24211-10-08T	1"X14	12	08	29	13.5	30	
24211-10-10	1"X14	16	10	34	13.5	30	
24211-10-12	1"X14	20	12	34	13.5	30	
24211-12-08T	1.3/16"X12	12	08	30.5	15	36	
24211-12-10T	1.3/16"X12	16	10	32.5	15	36	
24211-12-12	1.3/16"X12	20	12	36.5	15	36	
24211-12-16	1.3/16"X12	25	16	36	15	36	
24211-16-12T	1.7/16"X12	20	12	32.5	14.8	41	
24211-16-14T	1.7/16"X12	22	14	35	14.8	41	
24211-16-16T	1.7/16"X12	25	16	34.3	14.8	41	
24211-16-20	1.7/16"X12	32	20	39.5	14.8	41	
24211-20-16T	1.11/16"X12	25	16	34.5	15	50	
24211-20-20W	1.11/16"X12	32	20	42.5	15	50	
24211-20-24W	1.11/16"X12	40	24	42.5	15	50	
24211-24-20T	2"X12	32	20	36	14.8	60	
24211-24-24T	2"X12	40	24	37.2	14.8	60	

注: 1.上述代号用于编织软管。 2. 如需用于缠绕软管代号改为 24212-xx-xx。
NOTE : 1. FOR USE WITH BRAIDED HOSES 2. IF USE WITH SPIRAL HOSES , HOSE FITTINGS
SERIES NUMBER IS24212-XX-XX

软管接头 HOSE FITTING

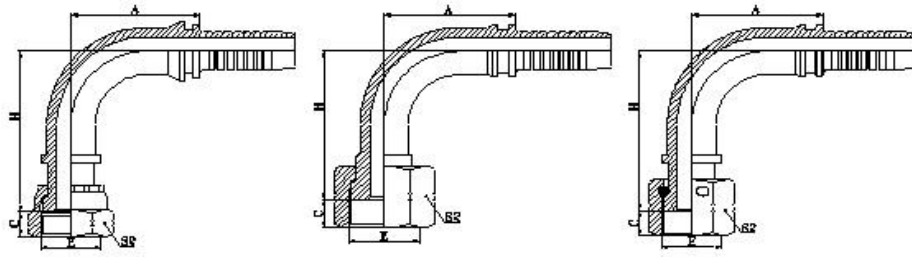

24291

24291-T

24291-W

90° 美制ORFS 内螺纹平面
90°ORFS FEMALE FLAT SEAT
ISO 12151-1—SAE J516

代 号	螺 纹 E	软 管		尺 寸			
		公称内径	标 号	A	H	C	S2
24291-04-04	9/16"X18	6	04	27.5	43.5	8.5	19
24291-04-05	9/16"X18	8	05	33	44	8.5	19
24291-06-05T	11/16"X16	8	05	33	37.5	10	22
24291-06-06	11/16"X16	10	06	33	50	10	22
24291-08-08	11/16"X16	12	08	42.5	55	10	22
24291-08-06T	13/16"X16	10	06	35.3	39.8	11	27
24291-08-08	13/16"X16	12	08	41	58	11	27
24291-08-10	13/16"X16	16	10	56.5	61.5	11	27
24291-10-08T	1"X14	12	08	41	46	13.5	30
24291-10-10	1"X14	16	10	48.5	67.5	13.5	30
24291-10-12	1"X14	20	12	50.5	75.5	13.5	30
24291-12-10T	1.3/16"X12	16	10	56	51.5	15	36
24291-12-12	1.3/16"X12	20	12	65.5	78	15	36
24291-12-16	1.3/16"X12	25	16	76.7	83.5	15	36
24291-16-12T	1.7/16"X12	20	12	65.5	63	14.8	41
24291-16-14T	1.7/16"X12	22	14	71.2	63	14.8	41
24291-16-16T	1.7/16"X12	25	16	76.9	67.5	14.8	41
24291-20-16T	1.11/16"X12	25	16	76.7	67.5	15	50
24291-20-20W	1.11/16"X12	32	20	93	100	15	50
24291-24-20T	2"X12	32	20	91.5	78.5	14.8	60
24291-24-24T	2"X12	40	24	109.4	92	14.8	60

注: 1.上述代号用于编织软管。 2. 如需用于缠绕软管代号改为 24292-xx-xx。

NOTE : 1. FOR USE WITH BRAIDED HOSES 2. IF USE WITH SPIRAL HOSES , HOSE FITTINGS SERIES NUMBER IS 24292-XX-XX.

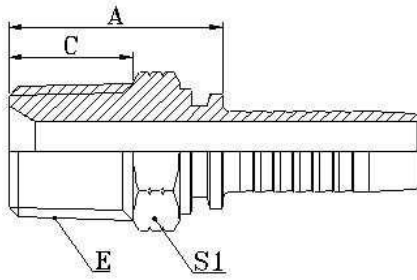

15611

美制布锥管外螺纹

NPT MALE

代 号	螺纹E	软 管		尺 寸			
		公称内径	标 号	A	C	S1	
15611-02-03	Z1/8"X27	5	03	21.5	10.5	12	
15611-02-04	Z1/8"X27	6	04	22.5	10.5	12	
15611-04-03	Z1/4"X18	5	03	27	15	17	
15611-04-04	Z1/4"X18	6	04	27.5	15	17	
15611-04-05	Z1/4"X18	8	05	27.5	15	17	
15611-04-06	Z1/4"X18	10	06	27.5	15	17	
15611-06-04	Z3/8"X18	6	04	29	16	19	
15611-06-05	Z3/8"X18	8	05	29	16	19	
15611-06-06	Z3/8"X18	10	06	29	16	19	
15611-06-08	Z3/8"X18	12	08	29.5	16	19	
15611-08-06	Z1/2"X14	10	06	33.5	19.5	22	
15611-08-08	Z1/2"X14	12	08	34	19.5	22	
15611-08-10	Z1/2"X14	16	10	35.5	19.5	22	
15611-12-08	Z3/4"X14	12	08	37	19.5	27	
15611-12-10	Z3/4"X14	16	10	37	19.5	27	
15611-12-12	Z3/4"X14	20	12	38.5	19.5	27	
15611-12-16	Z3/4"X14	25	16	39.5	19.5	32	
15611-16-10	Z1"X11.5	16	10	45	25.5	36	
15611-16-12	Z1"X11.5	20	12	45	25.5	36	
15611-16-16	Z1"X11.5	25	16	47.5	25.5	36	
15611-20-16	Z1.1/4"X11.5	25	16	49	26.5	46	
15611-20-20	Z1.1/4"X11.5	32	20	50.5	26.5	46	
15611-24-24	Z1.1/2"X11.5	40	24	53.5	27.5	50	
15611-32-32	Z2"X11.5	50	32	56.5	27.5	65	

注: 1.上述代号用于编织软管。 2. 如需用于缠绕软管代号改为 15612-xx-xx。

NOTE : 1. FOR USE WITH BRAIDED HOSES 2. IF USE WITH SPIRAL HOSES , HOSE FITTINGS SERIES NUMBER IS 15612-XX-XX.

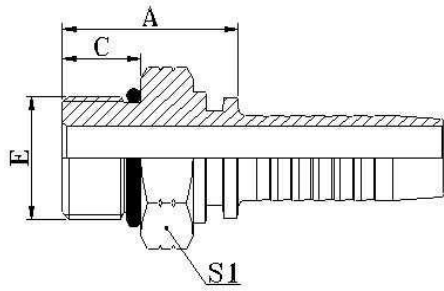

16011

美制SAE外螺纹带O形圈

SAE O-RING SEAL

ISO 11962-SAE J1926

代 号	螺纹E	软 管		O 形圈	尺 寸		
		公称内径	标 号		A	C	S1
16011-04-04	7/16"X20	6	04	O904	21.5	9.1	14
16011-05-04	1/2"X20	6	04	O905	21.5	9.1	17
16011-06-05	9/16"X18	8	05	O906	22.5	9.9	17
16011-06-06	9/16"X18	10	06	O906	22.5	9.9	17
16011-08-06	3/4"X16	10	06	O908	23.5	11.1	22
16011-08-08	3/4"X16	12	08	O908	24	11.1	22
16011-10-08	7/8"X14	12	08	O910	30	12.7	27
16011-10-10	7/8"X14	16	10	O910	31	12.7	27
16011-12-10	1.1/16"X12	16	10	O912	34	15.1	32
16011-12-12	1.1/16"X12	20	12	O912	34	15.1	32
16011-16-16	1.5/16"X12	25	16	O916	36	15.1	38

注: 1.上述代号用于编织软管。 2. 如需用于缠绕软管代号改为 16012-xx-xx。

NOTE : 1. FOR USE WITH BRAIDED HOSES 2. IF USE WITH SPIRAL HOSES , HOSE FITTINGS SERIES NUMBER IS 16012-XX-XX.

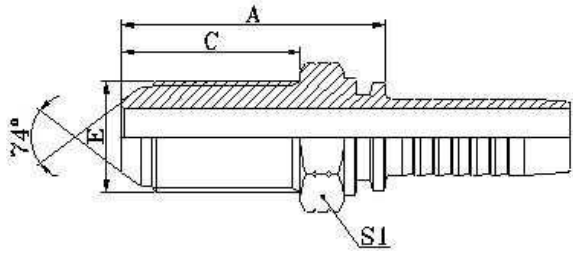

16711L

JIC 74°MALE CONE SEAL LONGER

美制JIC 外螺纹 74° 外锥面

代 号	螺纹E	软 管		尺 寸			
		公称内径	标 号	A	C	S1	
16711L-04-04	7/16"X20	6	04	43	30.5	17	
16711L-05-04	1/2"X20	6	04	43	30.5	19	
16711L-05-05	1/2"X20	8	05	43	30.5	19	
16711L-06-04	9/16"X18	6	04	47	32.5	22	
16711L-06-05	9/16"X18	8	05	47	32.5	22	
16711L-06-06	9/16"X18	10	06	47	32.5	22	
16711L-08-06	3/4"X16	10	06	51	36.5	24	
16711L-08-08	3/4"X16	12	08	51.5	36.5	24	
16711L-10-06	7/8"X14	10	06	56.5	40	30	
16711L-10-08	7/8"X14	12	08	57	40	30	
16711L-10-10	7/8"X14	16	10	58	40	30	
16711L-12-08	1.1/16"X12	12	08	63	44.5	36	
16711L-12-10	1.1/16"X12	16	10	64	44.5	36	
16711L-12-12	1.1/16"X12	20	12	64	44.5	36	
16711L-16-12	1.5/16"X12	20	12	66	44.5	41	
16711L-16-16	1.5/16"X12	25	16	67	44.5	41	
16711L-20-16	1.5/8"X12	25	16	70.5	45.7	50	
16711L-20-20	1.5/8"X12	32	20	71.2	45.7	50	
16711L-24-20	1.7/8"X12	32	20	71.5	46	55	
16711L-24-24	1.7/8"X12	40	24	71.5	46	55	

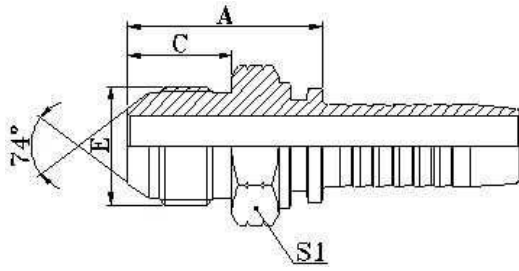

16711
美制JIC 外螺纹 74° 外锥面
JIC 74°MALE CONE SEAL

代 号	螺纹E	软 管		尺 寸			
		公称内径	标 号	A	C	S1	
16711-04-03	7/16"X20	5	03	26	14	12	
16711-04-04	7/16"X20	6	04	26	14	12	
16711-05-04	1/2"X20	6	04	26	14	14	
16711-05-05	1/2"X20	8	05	26	14	14	
16711-05-06	1/2"X20	10	06	26.5	14	17	
16711-06-04	9/16"X18	6	04	26.6	14.1	17	
16711-06-05	9/16"X18	8	05	26.6	14.1	17	
16711-06-06	9/16"X18	10	06	26.6	14.1	17	
16711-08-06	3/4"X16	10	06	30.7	16.7	22	
16711-08-08	3/4"X16	12	08	31.2	16.7	22	
16711-10-06	7/8"X14	10	06	34.3	19.3	24	
16711-10-08	7/8"X14	12	08	34	19.3	24	
16711-10-10	7/8"X14	16	10	35.8	19.3	24	
16711-12-08	1.1/16"X12	12	08	38.5	21.9	30	
16711-12-10	1.1/16"X12	16	10	39.4	21.9	30	
16711-12-12	1.1/16"X12	20	12	39.4	21.9	30	
16711-12-16	1.1/16"X12	25	16	42	21.9	30	
16711-14-10	1.3/16"X12	16	10	41.5	22.6	32	
16711-14-12	1.3/16"X12	20	12	40.5	22.6	32	
16711-16-12	1.5/16"X12	20	12	43.6	23.1	36	
16711-16-16	1.5/16"X12	25	16	45.1	23.1	36	
16711-20-16	1.5/8"X12	25	16	47	24.3	46	
16711-20-20	1.5/8"X12	32	20	48.3	24.3	46	
16711-24-20	1.7/8"X12	32	20	53	27.5	50	
16711-24-24	1.7/8"X12	40	24	53.5	27.5	50	
16711-32-32	2.1/2"X12	50	32	62.9	33.9	65	

注: 1.上述代号用于编织软管。 2. 如需用于缠绕软管代号改为 16712-xx-xx。

NOTE : 1. FOR USE WITH BRAIDED HOSES 2. IF USE WITH SPIRAL HOSES , HOSE FITTINGS SERIES NUMBER IS 16712-XX-XX.

软管接头 HOSE FITTING

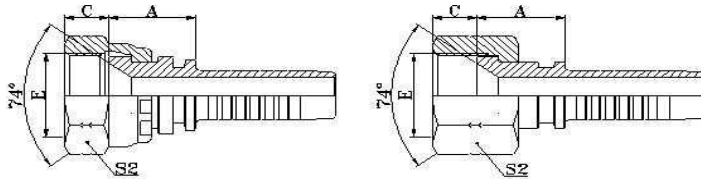

美制JIC 外螺纹 74° 内锥面

26711

26711-T

JIC FEMALE 74° CONE SEAT

代 号	螺纹 E	软 管		尺 寸			
		公称内径	标 号	A	C	S2	
26711-04-03	7/16"X20	5	03	14.5	9	15	
26711-04-04	7/16"X20	6	04	15	9	15	
26711-05-04	1/2"X20	6	04	16	9.5	17	
26711-05-05	1/2"X20	8	05	16	9.5	17	
26711-05-06	1/2"X20	10	06	16.5	9.5	17	
26711-06-04	9/16"X18	6	04	16.5	10.5	19	
26711-06-05	9/16"X18	8	05	16	10.5	19	
26711-06-06	9/16"X18	10	06	16.5	10.5	19	
26711-06-08	9/16"X18	12	08	16	10.5	19	
26711-08-06	3/4"X16	10	06	18	11	24	
26711-08-08	3/4"X16	12	08	18.5	11	24	
26711-08-10	3/4"X16	16	10	19.5	11	24	
26711-10-08	7/8"X14	12	08	19.5	13	27	
26711-10-10	7/8"X14	16	10	20.5	13	27	
26711-10-12	7/8"X14	20	12	20	13	7	
26711-12-08T	1.1/16"X12	12	08	19	15	32	
26711-12-10	1.1/16"X12	16	10	21.5	15	32	
26711-12-12	1.1/16"X12	20	12	21.5	15	32	
26711-12-16	1.1/16"X12	25	16	23.5	15	32	
26711-14-12	1.3/16"X12	20	12	21.5	15	36	
26711-16-12T	1.5/16"X12	20	12	18.5	16	41	
26711-16-16	1.5/16"X12	25	16	24.5	16	41	
26711-16-20	1.5/16"X12	32	20	24	16	41	
26711-20-16T	1.5/8"X12	25	16	23	17	50	
26711-20-20W	1.5/8"X12	32	20	26	17	50	
26711-24-20W	1.7/8"X12	32	20	26.5	20	55	
26711-24-24W	1.7/8"X12	40	24	26.5	20	55	
26711-32-24T	2.1/2"X12	40	24	27	23.5	75	
26711-32-32T	2.1/2"X12	50	32	27	23.5	75	

注: 1.上述代号用于编织软管。 2. 如需用于缠绕软管代号改为 26712-xx-xx。

NOTE : 1. FOR USE WITH BRAIDED HOSES 2. IF USE WITH SPIRAL HOSES , HOSE FITTINGS SERIES NUMBER IS26712-XX-XX.

软管接头 HOSE FITTING

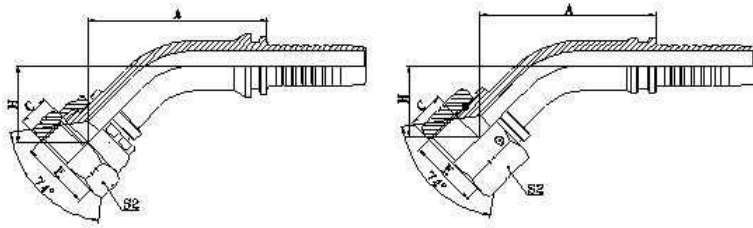

45° 美制JIC 内螺纹
74° 内锥面SAE J514
45°JIC FEMALE 74°CONE
SEAT

26741

26741-W

代 号	螺纹E	软 管		尺 寸			
		公称内径	标 号	A	C	H	S2
26741-04-03	7/16"X20	5	03	37.6	9	17.2	15
26741-04-04	7/16"X20	6	04	37	9	18	15
26741-05-04	1/2"X20	6	04	40.5	9.5	18.5	17
26741-05-05	1/2"X20	8	05	41.5	9.5	20	17
26741-05-06	1/2"X20	10	06	44.6	9.5	20.3	17
26741-06-04	9/16"X18	6	04	40.5	10.5	18.5	19
26741-06-05	9/16"X18	8	05	42	10.5	20.5	19
26741-06-06	9/16"X18	10	06	44	10.5	20.5	19
26741-08-06	3/4"X16	10	06	45	11	21.5	24
26741-08-08	3/4"X16	12	08	56.5	11	24	24
26741-10-08	7/8"X14	12	08	57.5	13	24.6	27
26741-10-10	7/8"X14	16	10	60	13	26	27
26741-10-12	7/8"X14	20	12	75.7	13	28.9	27
26741-12-08	1.1/16"X12	12	08	58	15	25.5	32
26741-12-10	1.1/16"X12	16	10	60.5	15	27	32
26741-12-12	1.1/16"X12	20	12	73.5	15	30	32
26741-14-12	1.3/16"X12	20	12	77.4	15	30	36
26741-16-12	1.5/16"X12	20	12	77.4	16	30	41
26741-16-16	1.5/16"X12	25	16	84	16	32.5	41
26741-20-20W	1.5/8"X12	32	20	95.9	17	35.2	50
26741-24-20W	1.7/8"X12	32	20	100.9	20	40.1	55
26741-24-24W	1.7/8"X12	40	24	114.8	20	44.1	55
26741-32-32T	2.1/2"X12	50	32	135.9	23.5	51.6	75

注: 1.上述代号用于编织软管。 2. 如需用于缠绕软管代号改为 26742-xx-xx。

NOTE : 1. FOR USE WITH BRAIDED HOSES 2. IF USE WITH SPIRAL HOSES , HOSE FITTINGS SERIES NUMBER IS26742-XX-XX.

软管接头 HOSE FITTING

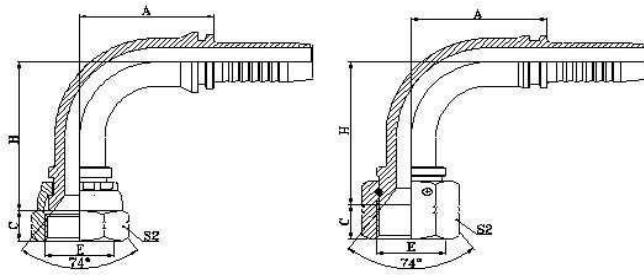

90° 美制JIC 内螺纹
 74° 内锥面SAE J514
 90°JIC FEMALE 74°CONE
 SEAT

26791

26791-W

代 号	螺纹E	软 管		尺 寸			
		公称内径	标 号	A	C	H	S2
26791-04-03	7/16"X20	5	03	26.5	9	30.5	15
26791-04-04	7/16"X20	6	04	27.5	9	33	15
26791-05-04	1/2"X20	6	04	27.5	9.5	33.5	17
26791-05-05	1/2"X20	8	05	31	9.5	38.5	17
26791-05-06	1/2"X20	10	06	35.3	9.5	39.3	17
26791-06-04	9/16"X18	6	04	27.5	10.5	34.5	19
26791-06-05	9/16"X18	8	05	31	10.5	39	19
26791-06-06	9/16"X18	10	06	33	10.5	40	19
26791-06-08	9/16"X18	12	08	35.8	10.5	39.8	19
26791-08-06	3/4"X16	10	06	33	11	41.5	24
26791-08-08	3/4"X16	12	08	42.5	11	48.5	24
26791-08-10	3/4"X16	16	10	49	11	47.5	24
26791-10-08	7/8"X14	12	08	42.5	13	49.5	27
26791-10-10	7/8"X14	16	10	48.5	13	54	27
26791-10-12	7/8"X14	20	12	50.5	13	62	27
26791-12-08	1.1/16"X12	12	08	42.5	15	50.5	32
26791-12-10	1.1/16"X12	16	10	48.5	15	55	32
26791-12-12	1.1/16"X12	20	12	60.5	15	63	32
26791-12-16	1.1/16"X12	25	16	74	15	63.5	32
26791-14-12	1.3/16"X12	20	12	65.5	15	63.5	36
26791-16-12	1.5/16"X12	20	12	65.5	16	63.5	41
26791-16-16	1.5/16"X12	25	16	66	16	75.5	41
26791-20-20W	1.5/8"X12	32	20	91.5	17	80.5	50
26791-24-20W	1.7/8"X12	32	20	91.5	20	80.5	55
26791-24-24W	1.7/8"X12	40	24	109.4	20	94	55
26791-32-32T	2.1/2"X12	50	32	133.1	23.5	121.8	75

注: 1.上述代号用于编织软管。 2. 如需用于缠绕软管代号改为 26792-xx-xx。

NOTE : 1. FOR USE WITH BRAIDED HOSES 2. IF USE WITH SPIRAL HOSES , HOSE FITTINGS SERIES NUMBER IS 26792-XX-XX.

26791K

90° 美制短身JIC 内螺纹

74° 内锥面SAE J514

90°JIC COMPACT FEMALE 74° CONE SEAT

代 号	螺纹E	软 管		尺 寸				
		公称内径	标 号	A	C	H	S1	S2
26791K-04-04	7/16"X20	6	04	17.5	9	18	11	15
26791K-06-04	9/16"X18	6	04	20	10.5	20.5	14	19
26791K-06-06	9/16"X18	10	06	20	10.5	20.5	16	19
26791K-08-06	3/4"X16	10	06	23	11	25	19	24
26791K-08-08	3/4"X16	12	08	23.5	11	25	22	24
26791K-10-08	7/8"X14	12	08	25	13	27	22	27
26791K-10-10	7/8"X14	16	10	25	13	27	22	27
26791K-12-12	1.1/16"X12	20	12	29	15	31	27	32
26791K-16-16	1.5/16"X12	25	16	43	16	34.3	33	41

注: 1.上述代号用于编织软管。 2. 如需用于缠绕软管代号改为 26792K-xx-xx。

NOTE : 1. FOR USE WITH BRAIDED HOSES 2. IF USE WITH SPIRAL HOSES , HOSE FITTINGS SERIES NUMBER IS26792K-XX-XX.

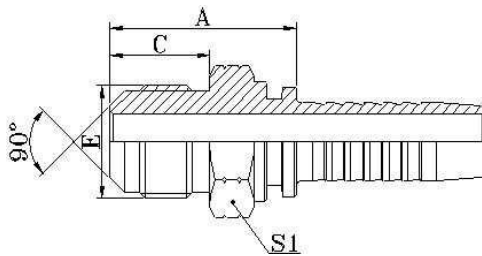

17811

美制 SAE 外螺纹 90° 外锥面

SAE MALE 90° CONE

代 号	螺 纹 E	软 管		尺 寸			
		公称内径	标 号	A	C	S1	
17811-04-04	7/16"X20	6	04	25.5	12.7	12	
17811-05-05	1/2"X20	8	05	27	14.2	14	
17811-06-06	5/8"X18	10	06	28.5	15.7	17	
17811-08-08	3/4"X16	12	08	34	19	22	
17811-10-10	7/8"X14	16	10	38.5	22.4	24	
17811-12-12	1.1/16"X14	20	12	44	25.4	30	

注: 1.上述代号用于编织软管。 2. 如需用于缠绕软管代号改为 17812-xx-xx。

NOTE : 1. FOR USE WITH BRAIDED HOSES 2. IF USE WITH SPIRAL HOSES , HOSE FITTINGS SERIES NUMBER IS 17812-XX-XX.

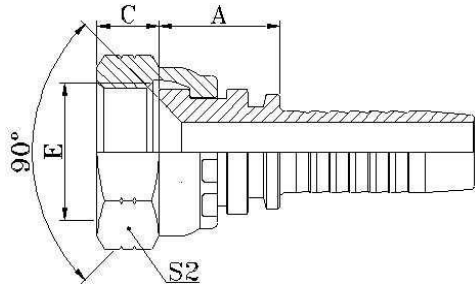

27811
 美制SAE 内螺纹90°
 内锥面SAE J513
 SAE FEMALE 90°CONE SEAT

代 号	螺纹E	软 管		尺 寸			
		公称内径	标 号	A	C	S2	
27811-04-03	7/16"X20	5	03	14	9	15	
27811-04-04	7/16"X20	6	04	15	9	15	
27811-05-05	1/2"X20	8	05	16	9.5	17	
27811-06-04	5/8"X18	6	04	17	11.3	22	
27811-06-05	5/8"X18	8	05	17	11.3	22	
27811-06-06	5/8"X18	10	06	17	11.3	22	
27811-08-08	3/4"X16	12	08	18.5	11	24	
27811-10-08	7/8"X14	12	08	18.5	13	27	
27811-10-10	7/8"X14	16	10	20.5	13	27	
27811-12-12	1.1/16"X14	20	12	21.5	14.3	32	

注: 1.上述代号用于编织软管。 2. 如需用于缠绕软管代号改为 27812-xx-xx。

NOTE : 1. FOR USE WITH BRAIDED HOSES 2. IF USE WITH SPIRAL HOSES , HOSE FITTINGS SERIES NUMBER IS27812-XX-XX.

软管接头 HOSE FITTING

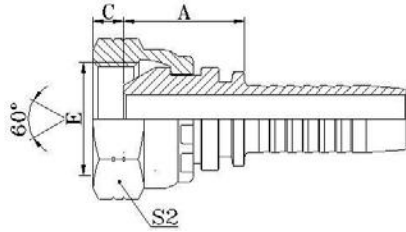

21611
 美制NPSM 内螺纹
 NPSM FEMALE 60° CONE
 60° 外锥面SAE J514

代 号	螺纹E	软 管		尺 寸			
		公称内径	标 号	A	B	S2	
21611-04-04	1/4"X18	6	04	18	4.6	19	
21611-04-06	1/4"X18	10	06	19	4.6	19	
21611-06-04	3/8"X18	6	04	19	6	22	
21611-06-05	3/8"X18	8	05	19	6	22	
21611-06-06	3/8"X18	10	06	19	6	22	
21611-08-08	1/2"X14	12	08	21.5	7.5	27	
21611-12-10	3/4"X14	16	10	24	8.9	32	
21611-12-12	3/4"X14	20	12	24	8.9	32	
21611-16-12T	1"X11.5	20	12	25	10.5	41	
21611-16-16	1"X11.5	25	16	27	10.5	41	
21611-20-20W	1.1/4"X11.5	32	20	29.5	11.2	50	
21611-24-24W	1.1/2"X11.5	40	24	29.5	11.2	55	

注: 1.上述代号用于编织软管。 2. 如需用于缠绕软管代号改为 21612-xx-xx。

NOTE : 1. FOR USE WITH BRAIDED HOSES 2. IF USE WITH SPIRAL HOSES , HOSE FITTINGS SERIES NUMBER IS21612-XX-XX.

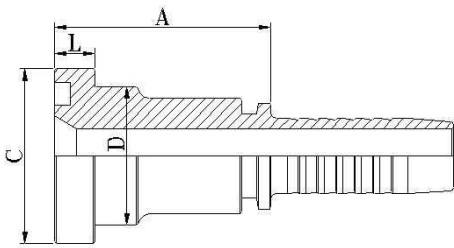

87312
SAE 法兰 3000PSI
SAE FLANGE 3000 PSI
ISO 12151-3—SAE J516

代 号	法兰型号	软 管		尺 寸			
		公称内径	标 号	A	C	D	L
87312-08-08	1/2"	12	08	45.5	30.2	24	6.73
87312-12-08	3/4"	12	08	47.5	38.1	31.7	6.73
87312-12-10	3/4"	16	10	49	38.1	31.7	6.73
87312-12-12	3/4"	20	12	48.5	38.1	31.7	6.73
87312-12-16	3/4"	25	16	49	38.1	31.7	6.73
87312-16-12	1"	20	12	51	44.4	38	8
87312-16-16	1"	25	16	48	44.4	38	8
87312-16-20	1"	32	20	53	44.4	38	8
87312-20-16	1.1/4"	25	16	57	50.8	43	8
87312-20-20	1.1/4"	32	20	56	50.8	43	8
87312-24-20	1.1/2"	32	20	68	60.3	50	8
87312-24-24	1.1/2"	40	24	74	60.3	50	8
87312-32-24	2"	40	24	70	71.4	62	9.53
87312-32-32	2"	50	32	70	71.4	62	9.53
87312-40-40	2.1/2"	64	40	76	84.1	74	9.53

注: 1.上述代号用于编织软管。 2. 如需用于缠绕软管代号改为 87312-xx-xx。

NOTE : 1. FOR USE WITH BRAIDED HOSES 2. IF USE WITH SPIRAL HOSES , HOSE FITTINGS SERIES NUMBER IS 87312-XX-XX.

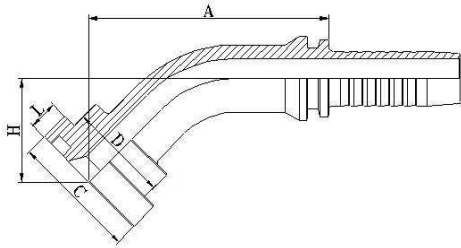

87342

45° SAE 法兰 3000PSI
45°SAE FLANGE 3000 PSI
ISO 12151-3—SAE J516

代 号	法兰型号	软 管		尺 寸				
		公称内径	标 号	A	C	D	H	L
87342-08-08	1/2"	12	08	56.5	30.2	24	23.5	6.73
87342-12-08	3/4"	12	08	58.9	38.1	31.7	24	6.73
87342-12-10	3/4"	16	10	69.9	38.1	31.7	25.3	6.73
87342-12-12	3/4"	20	12	73.5	38.1	31.7	29.5	6.73
87342-16-12	1"	20	12	76.3	44.4	38	28.9	8
87342-16-16	1"	25	16	83.	44.4	38	31	8
87342-16-20	1"	32	20	94.5	44.4	38	33.8	8
87342-20-16	1.1/4"	25	16	82	50.8	43	30.5	8
87342-20-20	1.1/4"	32	20	95	50.8	43	36	8
87342-24-20	1.1/2"	32	20	95.9	60.3	50	35.2	8
87342-24-24	1.1/2"	40	24	108	60.3	50	42	8
87342-32-24	2"	40	24	109.9	71.4	62	39.1	9.53
87342-32-32	2"	50	32	129.3	71.1	62	43	9.53

注: 1.上述代号用于编织软管。 2. 如需用于缠绕软管代号改为 87342-xx-xx。

NOTE : 1. FOR USE WITH BRAIDED HOSES 2. IF USE WITH SPIRAL HOSES , HOSE FITTINGS SERIES NUMBER IS 87342-XX-XX.

软管接头 HOSE FITTING

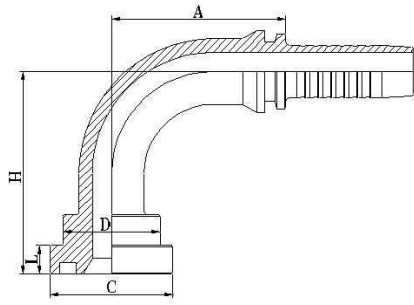

87392

90° SAE 法兰 3000PSI
90°SAE FLANGE 3000 PSI
ISO 12151-3—SAE J516

代 号	法兰型号	软 管		尺 寸				
		公称内径	标 号	A	C	D	H	L
87392-08-08	1/2"	12	08	42.5	30.2	24	48	6.73
87392-12-08	3/4"	12	08	42.5	38.1	31.7	50	6.73
87392-12-10	3/4"	16	10	56	38.1	31.7	52.5	6.73
87392-12-12	3/4"	20	12	60.5	38.1	31.7	62.5	6.73
87392-12-16	3/4"	25	16	76.7	38.1	31.7	67.5	6.73
87392-16-12	1"	20	12	65.5	44.4	38	62	8
87392-16-16	1"	25	16	66	44.4	38	74	8
87392-16-20	1"	32	20	91.5	44.4	38	78.5	8
87392-20-16	1.1/4"	25	16	76.7	50.8	43	67.5	8
87392-20-20	1.1/4"	32	20	75	50.8	43	86	8
87392-20-24	1.1/4"	40	24	107	50.8	43	78.5	8
87392-24-20	1.1/2"	32	20	75	60.3	50	90	8
87392-24-24	1.1/2"	40	24	89	60.3	50	102	8
87392-32-24	2"	40	24	109.4	71.4	62	94	9.53
87392-32-32	2"	50	32	115.5	71.4	62	129.5	9.53
87392-40-40	2.1/2"	64	40	131.8	84.1	74.4	116.3	9.53

注: 1.上述代号用于编织软管。 2. 如需用于缠绕软管代号改为 87392-xx-xx。

NOTE : 1. FOR USE WITH BRAIDED HOSES 2. IF USE WITH SPIRAL HOSES , HOSE FITTINGS SERIES NUMBER IS 87392-XX-XX.

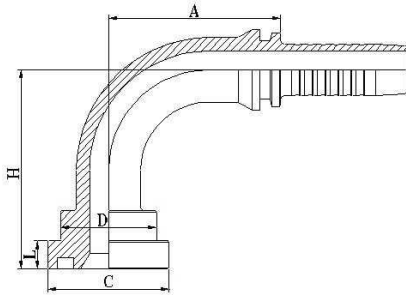

87392-H

90° SAE 法兰 3000PSI

90°SAE FLANGE SPECIAL HEIGHT

代 号	法兰型号	软 管		尺 寸				
		公称内径	标 号	A	C	D	H	L
87392-12-12(H90)	3/4"	20	12	65.5	38.1	32	90	6.73
87392-12-12(H100)	3/4"	20	12	65.5	38.1	32	100	6.73
87392-12-12(H127)	3/4"	20	12	65.5	38.1	32	127	6.73
87392-12-12(H150)	3/4"	20	12	65.5	38.1	32	150	6.73
87392-16-16(H100)	1"	25	16	76.7	44.4	38	100	8
87392-16-16(H127)	1"	25	16	76.7	44.4	38	127	8
87392-16-16(H150)	1"	25	16	76.7	44.4	38	150	8
87392-20-20(H100)	1.1/4"	32	20	91.5	50.8	43	100	8
87392-20-20(H157)	1.1/4"	32	20	91.5	50.8	43	127	8
87392-20-20(H150)	1.1/4"	32	20	91.5	50.8	43	150	8
87392-24-24(H127)	1.1/2"	40	24	109.4	50.8	50	127	8

FL 3000 PSI HALF FLANGE

FS 6000 PSI HALF FLANGE

SAE 对开法兰夹

代 号	法兰型号	尺 寸							压力等级 Mpa	
		A	B	D	H	M	N			
3000PSI										
FL-08	1/2"		54	45.6	9	6.2	38.1	17.5	M8X25	34.5
FL-12	3/4"		65	51.8	11	6.2	47.6	22.2	M10X30	
FL-16	1"		70	58.4	11	7.5	52.4	26.2	M10X30	
FL-20	1.1/4"		79	72.6	11	7.5	58.7	30.5	M10X30	27.6
FL-24	1.1/2"		91	82.2	13.5	7.5	69.9	35.7	M12X35	20.7
FL-32	2"		102	96.4	13.5	9	77.8	42.9	M12X35	
FL-40	2.1/2"		114	108.2	13.5	9	88.9	50.8	M12X40	17.2
FL-48	3"		135	130.6	17.5	9	106.4	61.9	M16X50	13.8
6000PSI										
FS-08	1/2"		56	47.2	9	7.2	40.5	18.2	M8X30	42
FS-12	3/4"		71	60	11	8.2	50.8	23.8	M10X35	
FS-16	1"		81	69.6	13.5	9	57.2	27.8	M12X45	
FS-20	1.1/4"		95	77.2	13.5	9.8	66.6	31.8	M12X45	
FS-24	1.1/2"		113	95	17.5	12	79.3	36.5	M16X55	
FS-32	2"		133	113.8	22	12	96.8	44.5	M20X70	

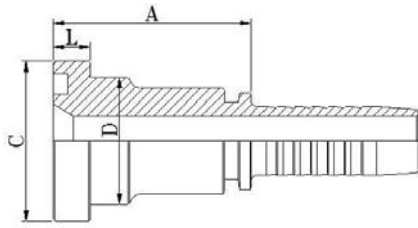

87612

SAE 法兰 6000PSI

SAE FLANGE 6000 PSI

ISO 12151-3—SAE J516

代 号	法兰型号	软 管		尺 寸				
		公称内径	标 号	A	C	D	L	
87612-08-08	1/2"	12	08	47.5	31.7	24	7.75	
87612-12-10	3/4"	16	10	50.5	41.3	32	8.76	
87612-12-12	3/4"	20	12	51.5	41.3	32	8.76	
87612-16-12	1"	20	12	56	47.6	38	9.53	
87612-16-16	1"	25	16	52.5	47.6	38	9.53	
87612-16-20	1"	32	20	61	47.6	38	9.53	
87612-20-16	1.1/4"	25	16	65	54	44	10.29	
87612-20-20	1.1/4"	32	20	62	54	44	10.29	
87612-24-20	1.1/2"	32	20	75	63.5	51	12.57	
87612-24-24	1.1/2"	40	24	79	63.5	51	12.57	
87612-32-24	2"	40	24	85	79.4	67	12.57	
87612-32-32	2"	50	32	79	79.4	67	12.57	

注: 1.上述代号用于编织软管。 2. 如需用于缠绕软管代号改为 87612-xx-xx。

NOTE : 1. FOR USE WITH BRAIDED HOSES 2. IF USE WITH SPIRAL HOSES , HOSE FITTINGS SERIES NUMBER IS 87612-XX-XX.

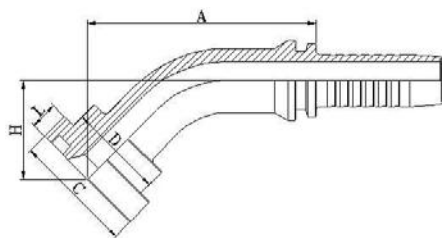

87642

45° SAE 法兰 6000PSI

45° SAE FLANGE 6000 PSI

ISO 12151-3—SAE J516

代 号	法兰型号	软 管		尺 寸				
		公称内径	标 号	A	C	D	H	L
87642-08-08	1/2"	12	08	57.5	31.7	24	25	7.75
87642-08-12	1/2"	20	12	77	31.7	24	29.6	7.75
87642-12-10	3/4"	16	10	72.5	41.3	32	28.2	8.76
87642-12-12	3/4"	20	12	75.5	41.3	32	32	8.76
87642-16-16	1"	25	16	86	47.6	38	34.	9.53
87642-20-20	1.1/4"	32	20	100	54	44	40	10.29
87642-24-20	1.1/2"	32	20	105.8	63.5	51	45.1	12.57
87642-24-24	1.1/2"	40	24	112	63.5	51	46	12.57
87642-32-24	2"	40	24	125.4	79.4	67	54.7	12.57
87642-32-32	2"	50	32	143	79.4	67	49	12.57

注: 1.上述代号用于编织软管。 2. 如需用于缠绕软管代号改为 87642-xx-xx。

NOTE : 1. FOR USE WITH BRAIDED HOSES 2. IF USE WITH SPIRAL HOSES , HOSE FITTINGS SERIES NUMBER IS 87642-XX-XX.

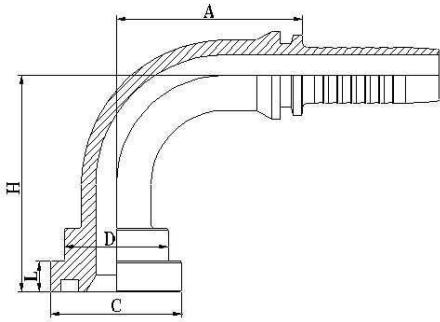

87692

90° SAE 法兰 6000PSI

90° SAE FLANGE 6000 PSI

ISO 12151-3—SAE J516

代 号	法兰型号	软 管		尺 寸				
		公称内径	标 号	A	C	D	H	L
87692-08-08	1/2"	12	08	42.5	31.7	24	50	7.75
87692-12-10	3/4"	16	10	56	41.3	32	56.5	8.76
87692-12-12	3/4"	20	12	50.5	41.3	32	65.5	8.76
87692-16-12	1"	20	12	65.5	47.6	38	69	9.53
87692-16-16	1"	25	16	66	47.6	38	78	9.53
87692-16-20	1"	32	20	91.5	47.6	38	85.5	9.53
87692-20-16	1.1/4"	25	16	76.7	54	44	78.5	10.29
87692-20-20	1.1/4"	32	20	75	54	44	92	10.29
87692-24-20	1.1/2"	32	20	91.5	63.5	51	94.5	12.57
87692-24-24	1.1/2"	40	24	89	63.5	51	107	12.57
87692-32-24	2"	40	24	109.4	79.4	67	116	12.57
87692-32-32	2"	50	32	115.5	79.4	67	138.5	12.57

注: 1.上述代号用于编织软管。 2. 如需用于缠绕软管代号改为 87692-xx-xx。

NOTE : 1. FOR USE WITH BRAIDED HOSES 2. IF USE WITH SPIRAL HOSES , HOSE FITTINGS SERIES NUMBER IS 87692-XX-XX.

软管接头 HOSE FITTING

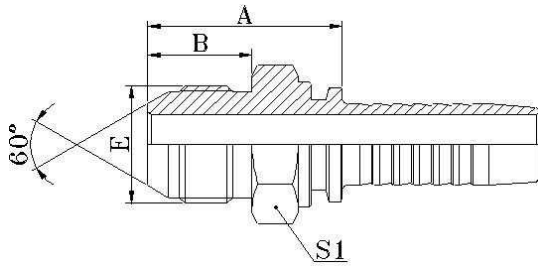

18611

日本公制外螺纹 60° 外锥面

JIS METRIC MALE 60° CONE SEAT

代 号	螺纹 E	软 管		尺 寸			
		公称内径	标 号	A	B	S1	
18611-14-04	M14X1.5	6	04	29.5	17	17	
18611-16-04	M16X1.5	6	04	30.5	18	17	
18611-16-06	M16X1.5	10	06	30.5	18	17	
18611-18-06	M18X1.5	10	06	30.5	18	19	
18611-20-08	M20X1.5	12	08	35	20	22	
18611-22-08	M22X1.5	12	08	35.5	20	24	
18611-24-10	M24X1.5	16	10	39.5	21.5	27	
18611-30-12	M30X1.5	20	12	45.5	26	32	
18611-33-16	M33X1.5	25	16	50.5	30	36	
18611-36-20	M36X1.5	32	20	56.5	33	38	
18611-42-24	M42X1.5	40	24	59.5	36	46	

注: 1.上述代号用于编织软管。 2. 如需用于缠绕软管代号改为 18612-xx-xx。

NOTE : 1. FOR USE WITH BRAIDED HOSES 2. IF USE WITH SPIRAL HOSES , HOSE FITTINGS SERIES NUMBER IS 18612-XX-XX.

软管接头 HOSE FITTING

日本公制内螺纹 60° 内锥面
JIC METRIC FEMALE 60°
CONE SEAT

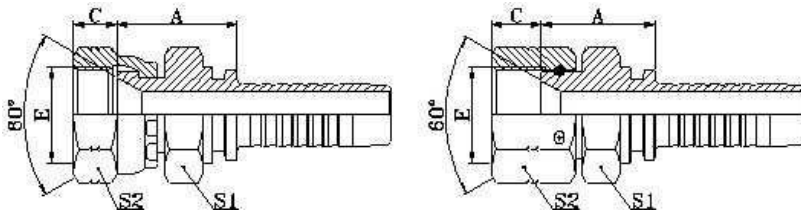

28611

28611-W

代 号	螺 纹 E	软 管		尺 寸			
		公称内径	标 号	A	B	S1	S2
28611-12-14	M12X1.5	6	04	20	9	17	17
28611-14-04W	M14X1.5	6	04	23	10.5	19	19
28611-14-06	M14X1.5	10	06	21	10.5	19	19
28611-16-04	M16X1.5	6	04	24	10	22	22
28611-16-05	M16X1.5	8	05	24	10	22	22
28611-16-06	M16X1.5	10	06	24	10	22	22
28611-18-06	M18X1.5	10	06	24	11.5	24	24
28611-18-08	M18X1.5	12	08	24.5	11.5	24	24
28611-20-08	M20X1.5	12	08	28.5	12	27	27
28611-22-08	M22X1.5	12	08	25.5	14	27	27
28611-24-08	M24X1.5	12	08	27.5	15	32	32
28611-24-10	M24X1.5	16	10	28	15	32	32
28611-30-12	M30X1.5	20	12	28.5	18.3	36	36
28611-33-12	M33X1.5	20	12	31	21.3	41	41
28611-33-16	M33X1.5	25	16	32	21.3	41	41
28611-36-20	M36X1.5	32	20	35.5	20	46	46
28611-42-24W	M42X1.5	40	24	36	18.8	55	55

注: 1.上述代号用于编织软管。 2. 如需用于缠绕软管代号改为 28612-xx-xx。

NOTE : 1. FOR USE WITH BRAIDED HOSES 2. IF USE WITH SPIRAL HOSES , HOSE FITTINGS SERIES NUMBER IS 28612-XX-XX.

软管接头 HOSE FITTING

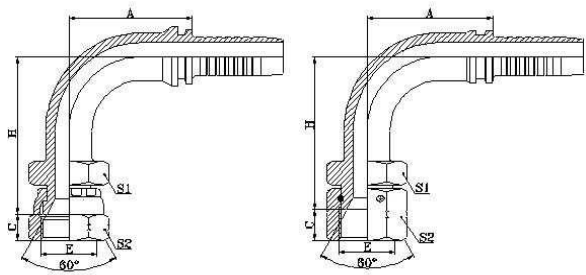

90° 日本公制内螺纹 60° 内锥面
90° JIS METRIC FEMALE 60° CONE SEAT

28691

28691-W

代 号	螺纹E	软 管		尺 寸				
		公称内径	标 号	A	B	H	S1	S2
28691-14-04W	M14X1.5	6	04	30	10.5	40	19	19
28691-14-06	M14X1.5	10	06	35.3	10.5	43.3	19	19
28691-16-05	M16X1.5	8	05	33	10	44	22	22
28691-18-06	M18X1.5	10	06	35.3	11.5	46.3	24	24
28691-22-08	M22X1.5	12	08	41	14	52.5	27	27
28691-24-10	M24X1.5	16	10	56	15	59	32	32
28691-30-12	M30X1.5	20	12	65.5	18.3	71.5	36	36
28691-33-16	M33X1.5	25	16	76.7	21.3	76	41	41
28691-36-20	M36X1.5	32	20	93	20	89	46	46
28691-42-24W	M42X1.5	40	24	109.4	18.8	108	55	55

注: 1.上述代号用于编织软管。 2. 如需用于缠绕软管代号改为 28692-xx-xx。

NOTE : 1. FOR USE WITH BRAIDED HOSES 2. IF USE WITH SPIRAL HOSES , HOSE FITTINGS SERIES NUMBER IS 28692-XX-XX.

19611

日本英制外螺纹 60° 外锥面JIS

GAS FEMALE 60° CONE SEAT

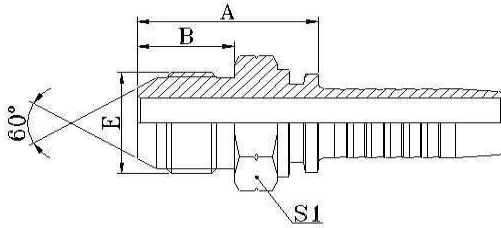

代 号	螺 纹 E	软 管		尺 寸			
		公称内径	标 号	A	B	S1	
19611-04-04	G1/4"X19	3	04	29	16	17	
19611-06-06	G3/8"X19	10	06	31	18	19	
19611-08-08	G1/2"X14	12	08	35.5	20	22	
19611-12-12	G3/4"X14	20	12	41	22	30	
19611-16-16	G1"X11	25	16	45.5	24	36	

注: 1.上述代号用于编织软管。 2. 如需用于缠绕软管代号改为 19612-xx-xx。
NOTE : 1. FOR USE WITH BRAIDED HOSES 2. IF USE WITH SPIRAL HOSES , HOSE FITTINGS SERIES NUMBER IS 19612-XX-XX.

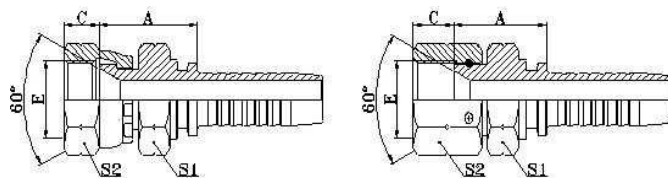

日本英制内螺纹 60° 内锥面JIS

GAS FEMALE 60° CONE SEAT
JIS B8363

29611

29611-W

代 号	螺 纹 E	软 管		尺 寸			
		公称内径	标 号	A	C	S1	S2
29611-02-03	G1/8"X28	5	03	20	7	14	14
29611-04-04	G1/4"X19	6	04	21	8	19	19
29611-04-05	G1/4"X19	8	05	21	8	19	19
29611-06-04	G3/8"X19	6	04	23	9	22	22
29611-06-06	G3/8"X19	10	06	23	9	22	22
29611-08-06	G1/2"X14	10	06	28	12	27	27
29611-08-08	G1/2"X14	12	08	26.5	12	27	27
29611-10-10	G5/8"X14	16	10	30.5	11.5	30	30
29611-12-10	G3/4"X14	16	10	30	13.5	32	32
29611-12-12	G3/4"X14	20	12	30.5	13.5	32	32
29611-16-16	G1"X11	25	16	32	16	41	41
29611-20-20W	G1.1/4"X11	32	20	43	18.5	50	50
29611-24-24W	G1.1/2"X11	40	24	43.5	19	55	55
29611-32-32W	G2"X11	50	32	46.5	23	70	70

注: 1.上述代号用于编织软管。 2. 如需用于缠绕软管代号改为 29612-xx-xx。
NOTE : 1. FOR USE WITH BRAIDED HOSES 2. IF USE WITH SPIRAL HOSES , HOSE FITTINGS SERIES NUMBER IS 29612-XX-XX.

软管接头 HOSE FITTING

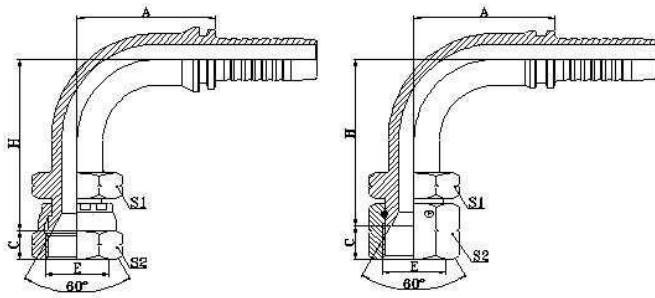

90° 日本英管内螺纹
 60° 内锥面 JIS B8363
 90°JIS GAS FEMALE 60°
 CONE SEAT

29691

29691-W

代 号	螺纹E	软 管		尺 寸				
		公称内径	标 号	A	C	H	S1	S2
29691-04-04	G1/4"X19	6	04	30	8	38	19	19
29691-04-05	G1/4"X19	8	05	34	8	41	19	19
29691-06-06	G3/8"X19	10	06	35.6	9	45.8	22	22
29691-08-08	G1/2"X14	12	08	41	12	53	27	27
29691-10-10	G5/8"X14	16	10	56.5	11.5	61	30	30
29691-12-12	G3/4"X14	20	12	65.5	13.5	69	32	32
29691-16-16	G1"X11	25	16	76.7	16	76.5	41	41
29691-20-20W	G1.1/4"X11	32	20	91.5	18.5	92.5	50	50
29691-24-24W	G1.1/2"X11	40	24	109.4	19	110.5	55	55
29691-32-32W	G2"X11	50	32	131.8	23	133.8	70	70

注: 1.上述代号用于编织软管。 2. 如需用于缠绕软管代号改为 29692-xx-xx。

NOTE : 1. FOR USE WITH BRAIDED HOSES 2. IF USE WITH SPIRAL HOSES , HOSE FITTINGS SERIES NUMBER IS 29692-XX-XX.

软管接头 HOSE FITTING

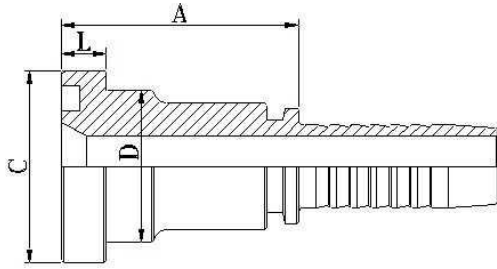

日制法兰 88111

JIS FLANGE

代 号	螺 纹 E	软 管		尺 寸				
		公称内径	标 号	A	C	D	L	
88111-10-08	5/8"	12	08	45	34.2	27.8	6.7	
88111-10-10	5/8"	16	10	45.5	34.2	27.8	6.7	
88111-10-12	5/8"	20	12	46	34.2	27.8	6.7	

注: 1.上述代号用于编织软管。 2. 如需用于缠绕软管代号改为 88112-xx-xx。

NOTE : 1. FOR USE WITH BRAIDED HOSES 2. IF USE WITH SPIRAL HOSES , HOSE FITTINGS SERIES NUMBER IS 88112-XX-XX.

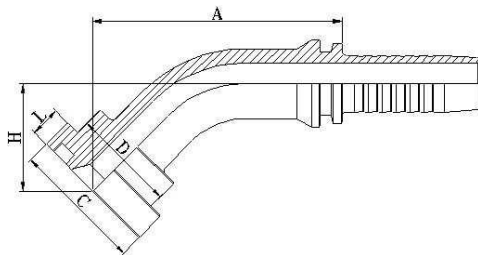

88141

45° 日制法兰
45° JIS FLANGE

代 号	螺 纹 E	软 管		尺 寸				
		公称内径	标 号	A	C	D	H	L
88141-10-08	5/8"	12	08	58.9	34.2	27.8	24	6.7
88141-10-10	5/8"	16	10	69.6	34.2	27.8	25.3	6.7
88141-10-12	5/8"	20	12	76.3	34.2	27.8	28.9	6.7

注: 1.上述代号用于编织软管。 2. 如需用于缠绕软管代号改为 88142-xx-xx。

NOTE : 1. FOR USE WITH BRAIDED HOSES 2. IF USE WITH SPIRAL HOSES , HOSE FITTINGS SERIES NUMBER IS 88142-XX-XX.

软管接头 HOSE FITTING

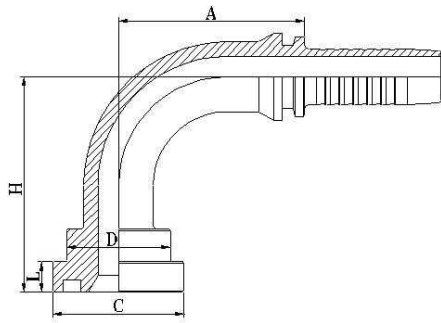

88191 90° 日制法兰 90°JIS FLANGE

代 号	螺 纹 E	软 管		尺 寸				
		公称内径	标 号	A	C	D	H	L
88191-10-08	5/8"	12	08	41	34.2	27.8	48	6.7
88191-10-10	5/8"	16	10	56	34.2	27.8	52.5	6.7
88191-10-12	5/8"	20	12	66.2	34.2	27.8	62	6.7

注: 1.上述代号用于编织软管。 2. 如需用于缠绕软管代号改为 88192-xx-xx。

NOTE : 1. FOR USE WITH BRAIDED HOSES 2. IF USE WITH SPIRAL HOSES , HOSE FITTINGS SERIES NUMBER IS 88192-XX-XX.

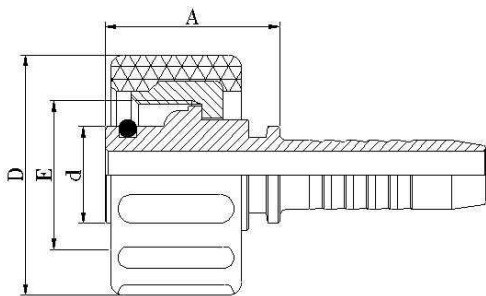

20011-ST 公制内螺纹高压水管 METRIC FEMALE WATERWASH INSERTS

代 号	螺 纹 E	软 管		尺 寸			
		公称内径	标 号	A	d	D	
20011-22-03ST	M22X1.5	5	03	24.5	14	34.5	
20011-22-04ST	M22X1.5	6	04	25	14	34.5	
20011-22-05ST	M22X1.5	8	05	25	14	34.5	
20011-22-06ST	M22X1.5	10	06	25	14	34.5	

注: 1.上述代号用于编织软管。 2. 如需用于缠绕软管代号改为 20012-xx-xx。

NOTE : 1. FOR USE WITH BRAIDED HOSES 2. IF USE WITH SPIRAL HOSES , HOSE FITTINGS SERIES NUMBER IS 20012-XX-XX.

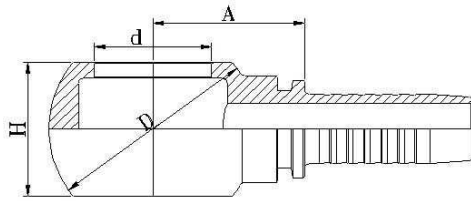

70011
公制铰接体
METRIC BANJO
DIN 7642

代 号	螺纹E	软 管		尺 寸			
		公称内径	标 号	A	d	D	H
70011-10-03	M10X1	5	03	14.5	10.1	17	10
70011-10-04	M10X1	6	04	17	10.1	17	10
70011-12-04	M12X1.5	6	04	20.5	12.1	20	12
70011-12-05	M12X1.5	8	05	20.5	12.1	20	12
70011-12-06	M12X1.5	10	06	20.5	12.1	20	12
70011-14-04	M14X1.5	6	04	19	14.1	24	14
70011-14-05	M14X1.5	8	05	19	14.1	24	14
70011-14-06	M14X1.5	10	06	21	14.1	24	14
70011-16-04	M16X1.5	6	04	20.5	16.1	28	16
70011-16-05	M16X1.5	8	05	20.5	16.1	28	16
70011-16-06	M16X1.5	10	06	20.5	16.1	28	16
70011-18-04	M18X1.5	6	04	23	18.1	32	20
70011-18-05	M18X1.5	8	05	24	18.1	32	20
70011-18-06	M18X1.5	10	06	24	18.1	32	20
70011-18-08	M18X1.5	12	08	24.5	18.1	32	20
70011-22-06	M22X1.5	10	06	28.1	22.1	39	25
70011-22-08	M22X1.5	12	08	28.5	22.1	39	25
70011-22-10	M22X1.5	16	10	27.5	22.1	39	25
70011-26-12	M26X1.5	20	12	30.5	26.1	46	30
70011-30-16	M30X1.5	25	16	37	30.1	54	36
70011-30-20	M30X1.5	32	20	41	30.1	54	36

注: 1.上述代号用于编织软管。 2. 如需用于缠绕软管代号改为 70012-xx-xx。

NOTE : 1. FOR USE WITH BRAIDED HOSES 2. IF USE WITH SPIRAL HOSES , HOSE FITTINGS SERIES NUMBER IS 70012-XX-XX.

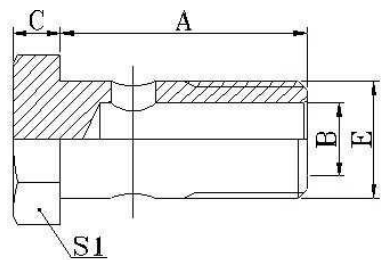

700M
公制铰接螺栓
METRIC BOLT
DIN 7643

代 号	螺纹E	尺 寸			
		A	B	C	S1
700M-10	M10X1	19	4	6	14
700M-12	M12X1.5	24	6	6	17
700M-14	M14X1.5	26	8	7	19
700M-16	M16X1.5	28	9	7.5	22
700M-18	M18X1.5	32	11	8	24
700M-22	M22X1.5	39	14	9	27
700M-26	M26X1.5	45	18	10	32
700M-30	M30X1.5	51	22	11	36

软管接头 HOSE FITTING

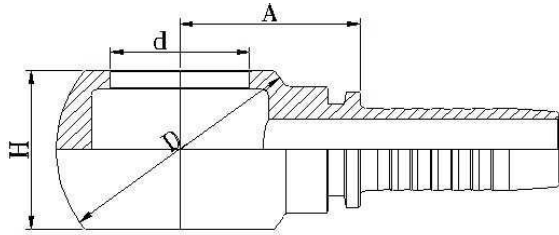

72011
英制铰接体
BSP BANJO

代 号	螺纹E	软 管		尺 寸			
		公称内径	标 号	A	d	D	H
72011-02-03	G1/8"X28	5	03	18	9.9	24	16
72011-02-04	G1/8"X28	6	04	18.5	9.9	24	16
72011-04-03	G1/4"X19	5	03	19	13.3	24	15
72011-04-04	G1/4"X19	6	04	19.5	13.3	24	15
72011-04-05	G1/4"X19	8	05	19.5	13.3	24	15
72011-04-06	G1/4"X19	10	06	19.5	13.3	24	15
72011-06-04	G3/8"X19	6	04	22	16.7	29	20
72011-06-05	G3/8"X19	8	05	22	16.7	29	20
72011-06-06	G3/8"X19	10	06	22	16.7	29	20
72011-06-08	G3/8"X19	12	08	23	16.7	29	20
72011-08-05	G1/2"X14	8	05	27.5	21	38	25
72011-08-06	G1/2"X14	10	06	27.5	21	38	25
72011-08-08	G1/2"X14	12	08	28	21	38	25
72011-08-10	G1/2"X14	16	10	29	21	38	25
72011-10-10	G5/8"X14	16	10	28	23	40	27
72011-12-10	G3/4"X14	16	10	32	26.5	48	31
72011-12-12	G3/4"X14	20	12	32	26.5	48	31
72011-16-08	G1"X11	12	08	40	33.3	60	42
72011-16-12	G1"X11	20	12	40	33.3	60	42
72011-16-16	G1"X11	25	16	41	33.3	60	42

注: 1.上述代号用于编织软管。 2. 如需用于缠绕软管代号改为 72012-xx-xx。

NOTE : 1. FOR USE WITH BRAIDED HOSES 2. IF USE WITH SPIRAL HOSES , HOSE FITTINGS SERIES NUMBER IS 72012-XX-XX.

软管接头 HOSE FITTING

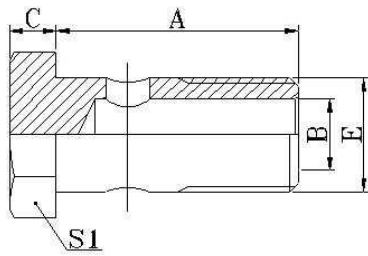

720B

英制铰接螺栓

BSP BOLT

代 号	螺 纹 E	尺 寸			
		A	B	C	S1
720B-02	G1/8"X28	29.5	4.8	4.8	14
720B-04	G1/4"X19	28.5	6	6	19
720B-06	G3/8"X19	38.5	9	7	22
720B-08	G1/2"X14	44	13	8.5	27
720B-10	G5/8"X14	48.5	15	10	30
720B-12	G3/4"X14	56	18	10	32
720B-16	G1"X11	68.5	22	13	41

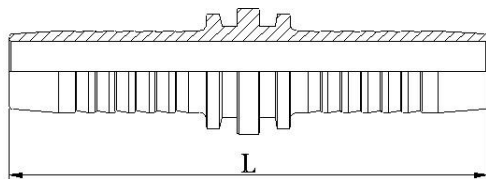

90011

双面连接芯

DOUBLE CONNECTOR

代 号	软 管		尺 寸			
	公称内径	标 号	L			
90011-04	6	04	69			
90011-05	8	05	69			
90011-06	10	06	73			
90011-08	12	08	77			
90011-10	16	10	89			
90011-12	20	12	96			
90011-16	25	16	114			
90011-20	32	20	132			
90011-24	40	24	162			
90011-32	50	32	170			

注: 用于编织软管. NOTE: FOR WIRE BRAID HOSE.

90012

双面连接芯

DOUBLE CONNECTOR

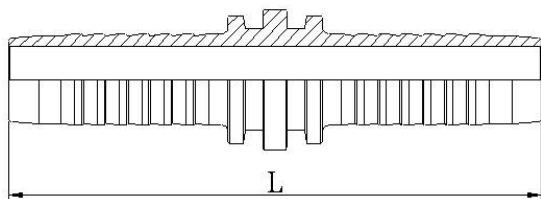

代 号	软 管		尺 寸			
	公称内径	标 号		L		
90012-04	6	04		83		
90012-05	8	05		87		
90012-06	10	06		87		
90012-08	12	08		91		
90012-10	16	10		97		
90012-12	20	12		111		
90012-16	25	16		134		
90012-20	32	20		153		
90012-24	40	24		172		
90012-32	50	32		178		

注:用于缠绕软管. NOTE:FOR SPRIAL HOSE.